

german  
brand  
award  
'17  
winner

Technical brochure

# emco entrance mat systems

Designing clean entrances





**Sustainable  
building**



Mitglied der  
**DGNB**

Deutsche Gesellschaft für Nachhaltiges Bauen  
German Sustainable Building Council

A building's sustainability can now be demonstrated with a series of national standards. In Germany, the DGNB (the German Sustainable Building Council) stipulates the minimum requirements for sustainable building products. All the components are taken into consideration when the evaluation is made – right down to the entrance matting. So the design and construction of a sustainable building requires an all-round approach. As the leading manufacturer of high-quality entrance mat systems, emco Bau is a member of the DGNB. This means we can offer you reliability when you choose from our tried-and-tested mat types DIPLOMAT and MARSCHALL, or our new development, the fully recyclable entrance mat emco ECOLINE® PIONEER.

It is essential that we use the resources we have responsibly, so that they are still available to future generations. As a manufacturing company, we are aware of this duty and are happy to take it on. Our high-quality, efficient entrance mat systems, with their customised designs, are an important part of a carefully thought-through building concept. People choose our clean-off systems out of respect for the building, its users and the environment.

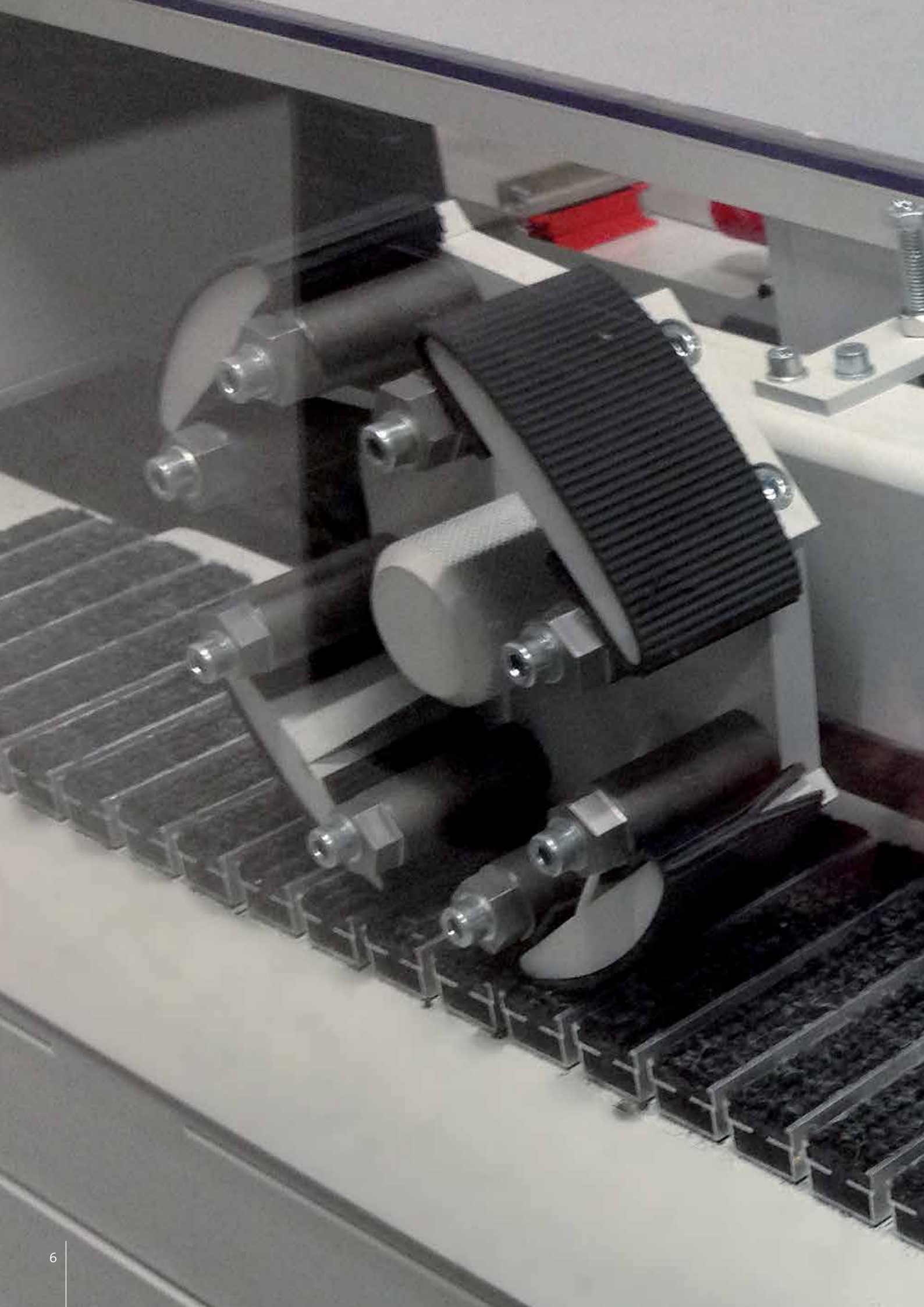

# Resilient and tough

We use high-quality raw materials for our entrance mats. In our product development, we place particular value on durability and stability. The result is exceptional entrance mats. This reduces long-term costs, conserves resources and reduces downtime. We guarantee end-to-end quality control from design to delivery. This is how we ensure that every entrance mat meets our high quality standards.

We get our own quality standards certified. In addition to this, our products regularly undergo external quality controls. Certificates for the management system in accordance with DIN EN ISO 9001:2008 and DIN EN ISO 14001:2009, together with test certificates for slip resistance and fire resistance, ensure the very highest quality standards.

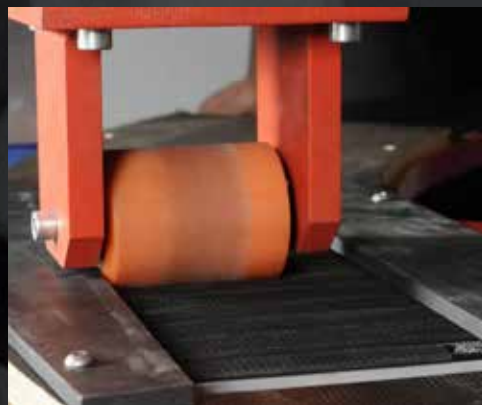

The high-quality materials used in our profiles, inserts and frames can be relied upon for weather-proofing and high strength. Our entrance mats are tested and undergo further development at regular intervals.





# Integrated planning



Every building interacts with its surroundings. It is the architect's task to define this interaction – sometimes introverted, sometimes extroverted, sometimes harmonious, sometimes full of contrasts. And every building has an inner structure shaped by its function and the spatial requirements. The entrance area is the interface between the building and its surroundings.

Treppe gewendet  
18 Stg. 17,7

1. Mezzanin

Oberlicht  
2,4 / 4,6 m

Erdgeschoss Foyer  
+ 0,00 = + 39,00 ü N.N.

Saubertlaufzone  
ca. 200 qm

8,000m

11,708m

16,0m

2,0m

17





# Cleanliness makes an entrance

As an area that serves multiple spatial and functional purposes and has a decisive effect on both the interior and exterior of the building, the entrance is a key part of an overall architectural concept. The options available for designing it and the elements used in the design are as versatile as the entrance area itself. This part of the building may indeed be inextricably linked to the facade from a functional perspective, but moving beyond this point – towards both the inside and outside – raises the question of how the entrance area should fulfil its spatial requirements. The entrance point itself acts as a kind of threshold or port, with issues such as protection, materials, design and technology at the heart of its concept.

Not only is it possible to incorporate emco entrance matting systems into a full, sophisticated design concept for the entrance area, but the systems also lend a helping hand to the design process. Although the systems naturally focus on protecting the building against dirt, our sophisticated 3-zone cleaning method, as well as high-quality materials, customised approach to production and painstakingly detailed solutions, allowing us to be incorporated into the design concept right from the start. And to assist the design process, emco offers a comprehensive service that takes in everything from planning to aftercare.



THE MOST POPULAR MANUFACTURER IN THE CATEGORY OF CLEAN-OFF ZONES

# Advanced building protection

As the entrance itself opens up into the entrance area, it also opens up space for a cleaning concept that is integrated, effective and thoroughly impressive. Combining emco aluminium mats that offer a range of different thicknesses and inserts in combination with emco clean off floor coverings, the 3-zone cleaning concept protects the building against virtually any kind of dirt, simply when people walk across the surface.

In zone 1, emco entrance mats with a rubber insert and/or a cassette brush collect coarse dirt. Zone 2 scrapes off fine dirt using the emco ribbed carpet insert, and zone 3 reduces damp and residual dirt using our emco clean off carpets. In areas that people step on directly from outside, we recommend installing dirt and damp collection elements that cover the entire width of the entrance (in line with accident insurance and prevention guidelines). These should be at least 2 mts long in the direction in which people will walk across them, 3 mts would be ideal.

Zone 1  
Coarse dirt



Zone 2  
Fine dirt



Zone 3  
Fine dirt and  
remaining moisture

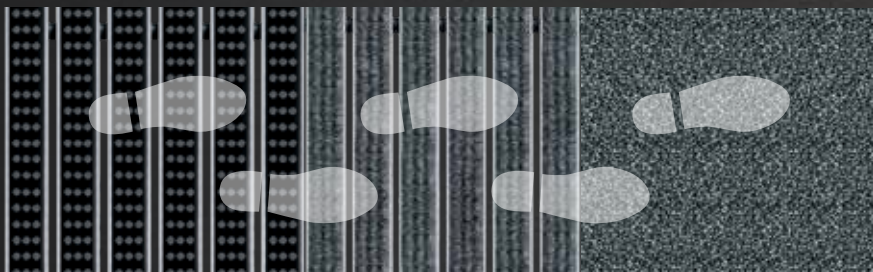

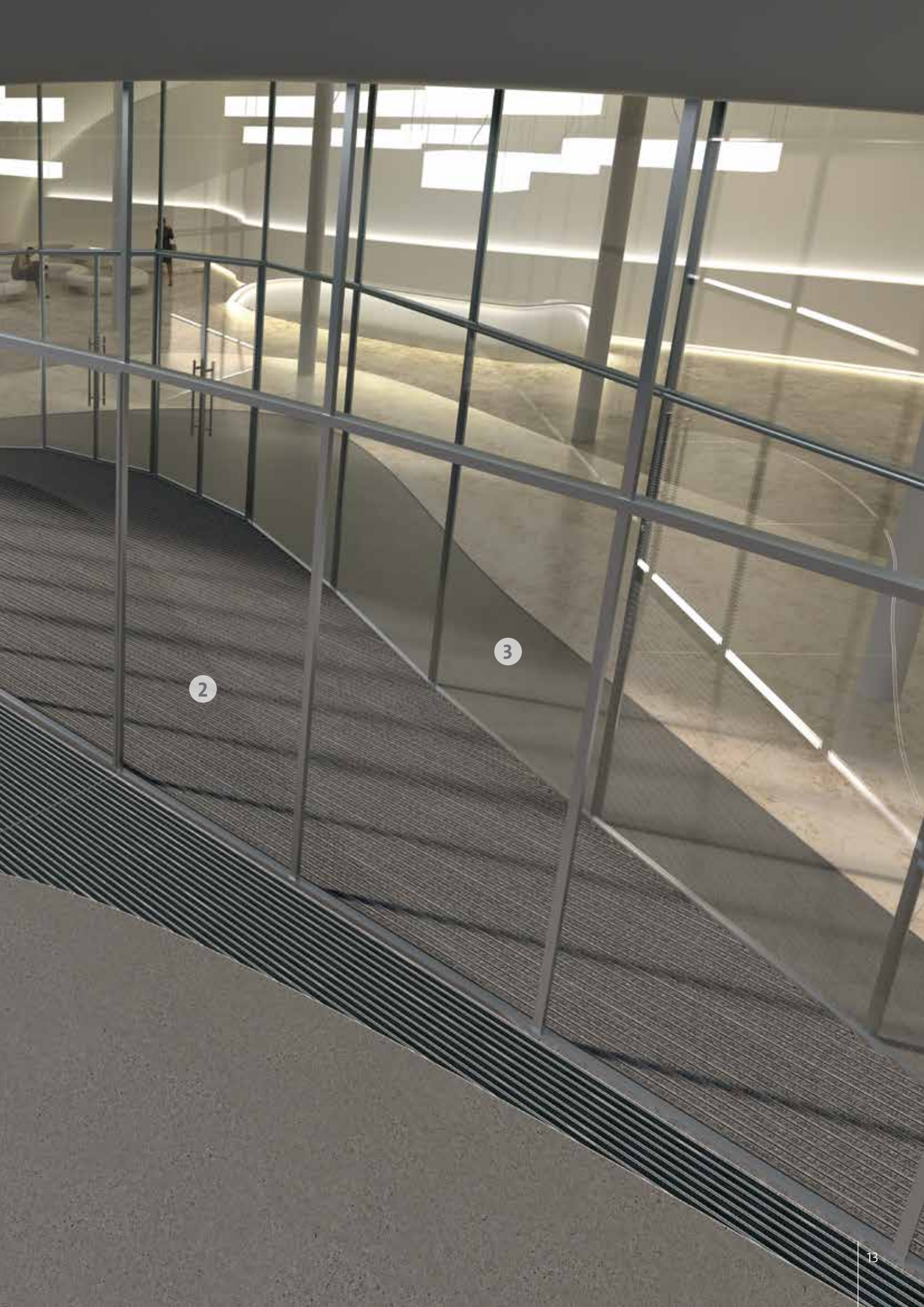

2

3



# CINEMA



**Combination – Classic**  
3-zone cleaning system in outdoor and indoor areas.



**Combination – Indoor**  
3-zone cleaning for indoor area only



**Combination – Outdoor**  
3-zone cleaning for outdoor and indoor area



# EMA

## The flexibility to plan any design.

With its combination of different mat types, the 3-zone cleaning concept offers a flexible system that can be integrated with ease into a whole range of different entrance areas. Its flexibility extends not only to the designs that can be used for each zone – incorporating different profile thicknesses, heights and inserts, for example – but also to the way in which the individual zones themselves can be combined. This means that the entrance area can be designed to suit the structural conditions and how heavily used the building in question is. But there's nothing variable about the benefits of this system:

- It significantly reduces cleaning costs, which not only saves money but also protects the environment as less water and fewer cleaning substances need to be used.
- It provides permanent protection against damage, dirt and de-icing salt burns for the floor covering inside the building, thus safeguarding the building's value over the long term.
- It considerably reduces the risk of accidents and slipping caused by damp and dirt on the floor.

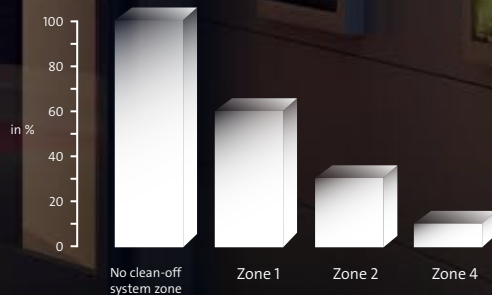

Cleaning costs (based on internal testing) in relation to the extent of the mat systems used

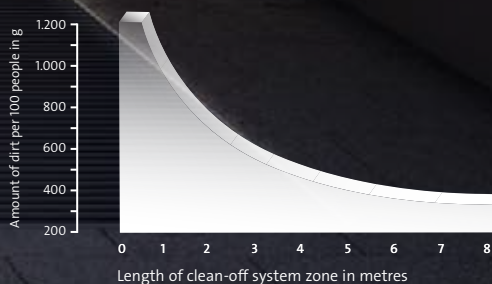

Reduction in the occurrence of dirt in relation to the length of the clean-off system zone

# Flawless functionality

The efficiency, functionality, resilience, flexibility and wide choice of system components that emco entrance mat systems offer make them a winning choice.

No matter what combination you choose, the functional inserts ensure efficient long-term dirt removal, since the dirt is collected in the gaps. The mats can be rolled up, allowing dirt to be removed from the mat well with the utmost ease.

The robust emco aluminium profiles stand up to consistently heavy loads and are completely unaffected by fluctuations in temperature. All proof of a top-quality product – just like the label says.





**EMCO**

[www.emco.de](http://www.emco.de)

+49(0)591-91400



**Tailor-made for  
every property**





An outstanding project only becomes an inviting building through responsible execution. Here, as in so many cases, the quality is in the detail. When the opportunity exists to employ high-quality products, with carefully considered configuration and design options, the possibilities become vast – as is the case with entrance mat systems from emco bau.



# As unique as the architecture itself

A discerning eye for design is what transforms an outstanding concept into a stunning building. That's why emco considers the manufacturing quality of its entrance mats to be of such importance. An experienced specialist in this area, the company has developed its expertise by trading for more than 50 years and uses state-of-the-art technology. It takes a precision approach to creating customised shapes and designs. As well as this, emco offers a comprehensive building service that provides planners and architects with support throughout the process – from the planning stage to tendering and making designs a reality, right through to service and maintenance. emco not only aims to support the design process through its entrance mat systems – it also makes sure to deliver on this aim.

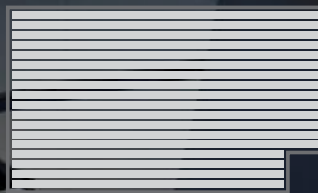

Square cut-outs

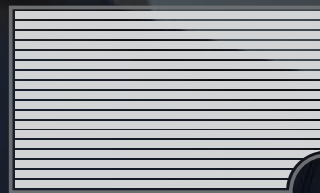

Round cut-outs



Curved designs



Angled designs



Square

# Customised appearance

If a company's entrance area aims to be the first impression that company gives, then a design that includes corporate colours is an ideal way to achieve this. Colours are the method of choice when it comes to creating special effects – whether the intention is to make a brand more recognisable, foster a harmonious overall image or make an exciting contrast. For this reason, our carpet and ribbed carpet inserts are available in a whole range of different colours that are completely unaffected by dirt.

## Standard colours



Anthracite  
No. 200



Light grey  
No. 220



Beige  
No. 420



Blue  
No. 114

## Special colours



Mauve  
No. 374



Brown  
No. 445



Turquoise  
No. 050



Sand  
No. 430

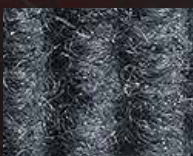

Blue/grey  
No. 113



Red  
No. 305



Royal blue  
No. 100



Grape  
No. 112

Approximate color reproduction. Printing cannot be faithfully reproduced the colors listed.





**WELCOME**

# Sophisticated details

The overall image that a product conveys, as well as how durable and user-friendly it is, relies not only on its quality but also on its attention to detail. That's why our entrance mats come with the addition of sophisticated details and accessory solutions, from profile strips to accentuating features, right through to matching inserts. As well as this, our installation frames, dirt collection wells and substructures are always designed to suit the building in question and the types of loads it is expected to withstand.

One special detail is our laser-cut stainless steel profile emco INOX®, which can be integrated into the emco entrance mat together with your company name/logo or other text.



The emco INOX® QUADRO with individual lettering, with a prestigious logo plate for effective promotion in an entrance mat system

# A radiant solution

Because we take an all-encompassing approach to design, we understand the impressions that a building gives at different times of the day and year – one example is what happens when it gets dark. emco LUMINA is our solution to this situation. This illuminated frame system, featuring maintenance-free, energy-saving LED lighting, not only helps illuminate the entrance matting at night but also makes it easier for users to find their way. The result is an entrance area that is just as inviting during the winter months or twilight as it is on a bright day. emco LUMINA makes a real impact by using dots of light, where as LUMINA VIA's continuous illuminated edge gives the mat a more refined look.

*For more information, please refer to p. 74-75.*



With emco LUMINA VIA, you can choose specific colours and opt to control the system via remote control, smartphone or tablet PC.



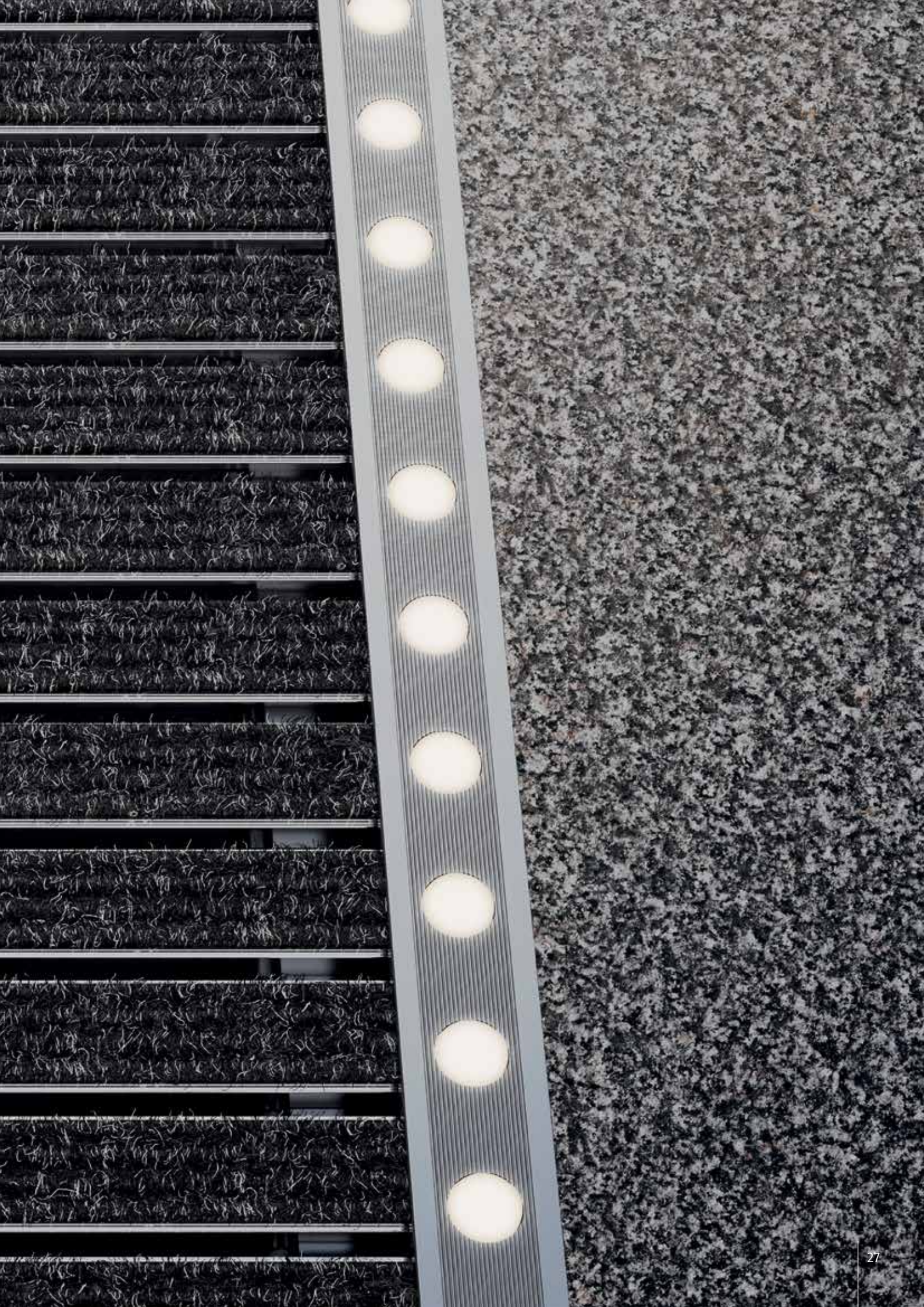



**1. Material quality.** emco entrance mats enjoy an outstanding reputation which they have earned thanks mainly to their resistance to weathering, excellent resilience and functionality. emco supporting chassis are made from a high-quality aluminium alloy and are equipped with superior inserts which are a perfect fit. In addition, emco offers matching frames in aluminium, brass and stainless steel.



**2. Innovation.** Thanks to emco's core competency, the company was able to develop and produce emco ECOLINE® PIONEER, the entrance mat that keeps re-inventing itself. At the same time, useful and attractive product variations are being added to the existing product range all the time, such as emco LUMINA, the illuminated frame system, SENATOR, the mat with extra-wide profiles, or the closed mat GS17. Our technical expertise is demonstrated with our laser measuring devices, mobile ribbed carpet replacement machines and technologically advanced manufacturing processes.



**3. Durability.** emco entrance mat systems consist of high-quality components that guarantee a long service life. Our ribbed carpet replacement (insert replacement) service extends the useful life of emco entrance mats, keeps investment costs down and is environmentally friendly.



**4. Ecology.** emco is a member of the German Sustainable Building Council (DGNB). emco entrance mats significantly reduce the effort and expense of cleaning adjacent floor coverings. The result is lower water consumption and reduced use of chemical substances, to the benefit of the environment. When it reaches the end of its service life, the emco ECOLINE® PIONEER entrance mat can be recycled 100% in entrance mat production. All our production uses sustainably sourced raw materials.



**5. Safety.** We subject every single one of the products in the emco range of entrance mat systems to rigorous testing, both in-house and at external independent locations. What is more, emco aluminium entrance mats demonstrate slip-resistant properties, offering the best possible prevention of accidents in compliance with DIN 51130 (according to resistance type: R 9, R 10, R 11 and R 13). In this way, we help to reduce the risk of accidents whilst also significantly improving hygiene levels in heavily frequented areas.



**6. Fire resistance.** Many emco entrance mat systems with ribbed/rubber inserts and/or cassette brushes are available, for an additional charge, in a flame-resistant version with fire classification Cfl-s1 or Bfl-s1 in accordance with EN 13501-1.



**7. Warranty.** As the result of feedback from our customers, we know that emco entrance mat systems offer reliable quality for the long haul, if however, they do demonstrate defects and it has not been possible to trace these back to improper usage, then our statutory product warranty and guarantee conditions will of course apply.



**8. On-site service.** Our service team will plan and install individually tailored emco entrance matting systems on site, exactly in accordance with your wishes and the specifications of the building in question. Equipped with a mobile ribbed carpet replacement machine and laser measurement devices, we are always at your service and our highly competent sales team will be happy to advise you, what ever your location.

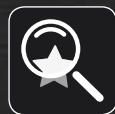

**9. Quality control.** Before we dispatch any emco entrance mats off to its destination, it undergoes a thorough testing process on the basis of a checklist to make sure it is of the highest possible quality, and we document the results. Each mat also receives a test number.



**10. Quality assurance.** Working together with Bielefeld University of Applied Sciences, we submit selected emco products for static and dynamic testing using a variety of test systems. Since 1995, the university has run an annual certification programme in accordance with DIN EN ISO 9001:2008. All of the emco entrance mat types that feature the "Test am Teuto" seal have been tested and certified by Bielefeld University of Applied Sciences in accordance with their type (fully supported or self-supporting).

# Ten good reasons to rely on emco

emco has been producing entrance mat systems to the highest standards of quality for more than 50 years. Offering users maximum freedom to create the design they want as well as superior reliability, they play a key role in creating a harmonious first impression at the entrance to a building, in a way that is in keeping with the overall architectural concept. emco works on a solid foundation of innovation, material quality, ecology, safety and service before, during and after production.



# Profile combination

The outstanding levels of functionality and effectiveness that our entrance mat systems offer are down to the wide choice of system components (profile and insert variants) available, which make it possible to tailor entrance mats to individual requirements.

emco entrance mats can be supplied in a range of different profile heights and material thicknesses. As a rule:

- As the construction height increases, so too does the mat's capacity for accumulating dirt, like a dustbin.
- The thicker the material, the higher its potential resilience.
- All profiles are made from high-quality aluminium, which means they are unaffected by fluctuations in temperature and offer long-term durability.

The installation location and the type of dirt that occurs in these areas determine the type of insert to be used. Additional profiles enhance the system's cleaning effectiveness.

Any combination of profiles and inserts are manufactured exactly in accordance with the specifications from the planning stage. Once this mat has been produced, the mat can be rolled up: a plus point not only for delivery and installation, but also for maintenance purposes, as it enables the mat to be lifted easily or rolled up and then the dirt removed by brush or vacuum cleaner, except GS17.



### Construction heights

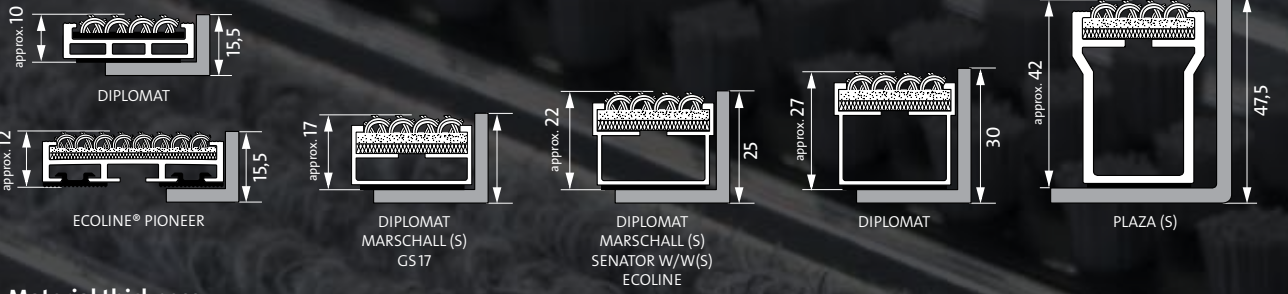

### Material thickness

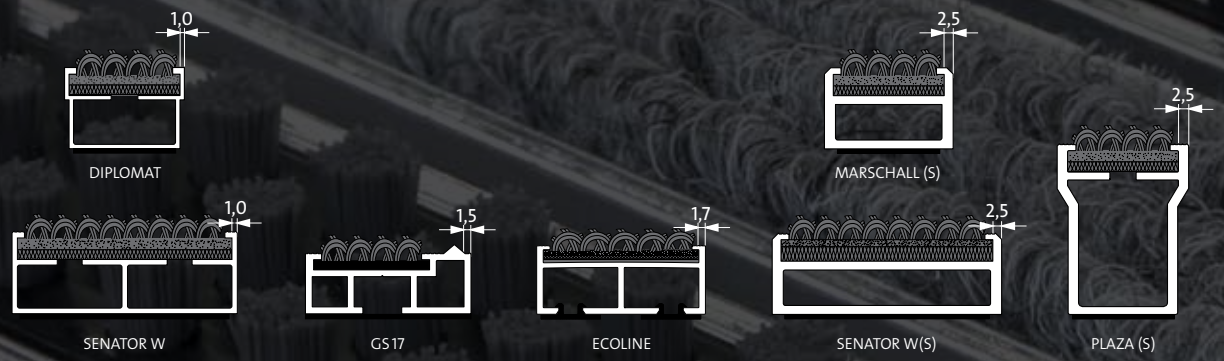

### Inserts



### Additional profiles



### Details of the combinations for the profiles available

<b>S</b>	Entrance mats for very heavy and exceptionally heavy loads (MARSCHALL and PLAZA types)
<b>W</b>	Entrance mats with extra-wide profiles (SENATOR types)
<b>RD</b>	Entrance mats with curved profiles (RADIAL type)
<b>GS</b>	Closed entrance mats with integrated scraper bar

### Details of the combinations of the inserts available

<b>G</b>	Rubber insert	<b>RB</b>	Ribbed carpet insert with brush strip*
<b>GB</b>	Rubber insert with brush strip*	<b>RK</b>	Ribbed carpet insert with scraper bar*
<b>GK</b>	Rubber insert with scraper bar*	<b>RG</b>	Ribbed carpet insert with rubber insert
<b>GCB</b>	Rubber insert with cassette brush	<b>RCB</b>	Ribbed carpet insert with cassette brush
<b>CB</b>	Cassette brush	<b>M</b>	MAXIMUS clean-off insert in standard colours, with customised image printing option
<b>R</b>	Ribbed carpet insert		

### Inserts and additional profiles

Zone	Type of dirt	Description	Weather effects, installation location	Recommended insert	Additional profile for increased effectiveness*	Recommended mat types
1	Coarse dirt	Street dust, sand, ash, textile fibres, small leaves and twigs, loose chippings, coarse sand, small gravel particles	Protected (indoors)	Rubber (G) Ribbed carpet with rubber (RG) Cassette brush (CB) Ribbed carpet with cassette brush (RCB)	Brush (B) Scraper bar (K)	CB G GB GK RB RCB RG RK
			Not protected (outdoors)	Rubber (G) Cassette brush (CB) Rubber with cassette brush (GCB)	Brush (B) Scraper bar (K)	G GB GCB GK
2	Fine dirt	Street dust, sand, ash, textile fibres, small leaves and twigs, etc.	Protected (indoors)	Ribbed carpet (R) Ribbed carpet with rubber (RG) Ribbed carpet with cassette brush (RCB) MAXIMUS (M)	Brush (B) Scraper bar (K)	M R RB RCB RG RK
			Not protected (outdoors)	Rubber (G) Cassette brush (CB) Rubber with cassette brush (GCB)	Brush (B) Scraper bar (K)	CB G GB GCB GK
3	Remaining fine dirt and moisture	Damp street dust, damp sand deposits, dust, etc.	Protected (indoors)	emco clean Off entrance matting systems	—	—
			Not protected (outdoors)	—	—	—

\* Additional profiles are only available with DIPLOMAT mats.

## Product enquiry

You can obtain a quote for the entrance mat system of your choice quickly and easily on our home page.

[www.emco-bau.com](http://www.emco-bau.com)



## Short overview

<b>Load capacity</b>	Normal ■ ■ ■ ■ ■ Detached houses, doctors surgeries, boutiques, small shop entrance areas (up to 400 passages per day, G up to 800 passages per day)	Heavy ■ ■ ■ ■ ■ Administrative buildings, banks, schools, business premises with average numbers of visitors (up to 2000 passages per day)				Very heavy ■ ■ ■ ■ ■ Shopping centres, airports, very heavily frequented entrance areas (2000 or more passages per day)	Exceptionally heavy ■ ■ ■ ■ ■ Shopping centres, airports, exceptionally heavily frequented entrance areas (5000 or more passages per day)	
	<b>Suitability for wheeled traffic</b>	Wheelchairs, shopping trolleys, hand trolleys (caution with GB, GK, GCB, CB, RB, RK, RCB)*				Wheelchairs, shopping trolleys, hand trolleys, cars, pallet trucks (caution with CB, GCB, RCB)*		
<b>Construction height</b>	Approx. 10 mm	17 mm	22 mm	27 mm	17 mm	22 mm	42 mm	

### Entrance mats for outdoor areas (zone 1)





<b>Rubber insert</b>	510 G	517 G	522 G	527 G	517 S/G	522 S/G	542 S/G
			522 TLS/G		GS 17 G	522 TLS/SG	
			22 SPIN/G				
<b>Rubber insert and brush strip</b>		517 GB	522 GB				
<b>Rubber insert and scraper bar</b>	510 GK	517 GK	522 GK	527 GK			
<b>Cassette brush</b>	510 CB	517 CB	522 CB	527 CB	517 S/CB	522 S/CB	542 S/CB
<b>Rubber insert and cassette brush</b>	510 GCB	517 GCB	522 GCB	527 GCB	517 S/GCB	522 S/GCB	542 S/GCB
<b>OUTDOOR insert</b>			522 W/OUTDOOR			522 WS/OUTDOOR	

### Entrance mats for indoor and covered outdoor areas (zones 2 + 3)

<b>Ribbed carpet insert</b>	510 R	517 R	522 R	527 R	517 S/R	522 S/R	542 S/R
	515 R Height approx. 15 mm				GS 17 R	522 RD/R	
			522 W/R			522 WS/R	
			522 TLS/R			522 TLS/SR	
			22 SPIN/R				
<b>Ribbed carpet insert and brush strip</b>		517 RB	522 RB				
			522 W/RB				
<b>Ribbed carpet insert and scraper bar</b>	510 RK	517 RK	522 RK	527 RK			
			522 W/RK				
<b>Ribbed carpet inset and cassette brush</b>	510 RCB	517 RCB	522 RCB	527 RCB	517 S/RCB	522 S/RCB	542 S/RCB
			522 W/RCB			522 WS/RCB	
<b>Ribbed carpet and rubber insert</b>	510 RG	517 RG	522 RG	527 RG	517 S/RG	522 S/RG	542 S/RG
			522 TLS/RG			522 TLS/SRG	
<b>Rubber insert</b>			22 SPIN/G				
<b>MAXIMUS insert</b>		517 M	522 M	527 M			
			522 W/M				
<b>Desso AirMaster®</b>	12					22	
<b>Frame type height</b>	500/13 15,5 mm	500/20 20 mm	500/25 25 mm	500/30 30 mm	500/20 20 mm	500/25 25 mm	500/46 46 mm

\* Versions featuring brush strips, scraper bars and cassette brushes are only suitable for wheeled traffic under certain conditions. Please contact us for further information.

Key:

								
DIPLOMAT	MARSCHALL	PLAZA	RADIAL	GS 17	SENATOR	TLS	KADETT (plastic)	ECOLINE



**emco DIPLOMAT**





**Ideal for hotels, business premises, doctors surgeries, private entrance areas and most medium to heavy contract installations.**



normal  
to heavy

emco DIPLOMAT entrance mats are suitable for normal to heavy loads thanks to the wide range of options available, it can provide the right solution for any requirement including heavily frequented buildings, extreme weather situations and areas that have special aesthetic demands.

*Zone 1, outdoor area: DIPLOMAT 522 G  
Zone 2, indoor area: DIPLOMAT 522 R*

Great results with replaceable inserts. For residential buildings and business premises with average numbers of visitors. Particularly suitable for picking up fine dirt (zone 2).



# emco DIPLOMAT

## with ribbed carpet insert

- Recommended for:** Indoor and covered outdoor areas
- Load-bearing capacity:** Normal to heavy
- Description:** Roll-up, hard-wearing entrance mat for laying on the floor. Mats produced to fit width and walking depth specifications perfectly, without the need for adjustment profiles. Any geometric shape is available.
- Passages:** Up to 2000 passages/day (type 510R and 510 RK up to 400 passages/day)
- Suitability for wheeled traffic:** Wheelchairs, (shopping trolleys), hand trolleys
- Support chassis:** Made from rigid aluminium with sound insulation underlay
- Tread surface:** Recessed, robust, weather-proof ribbed carpet strips  
Type RB: With additional brush strips mounted between the profiles  
Type RK: With additional scraper bars mounted between the profiles

**Non-slip properties:** R 11 slip resistance (type RK/R 10) as per DIN 51130

**DIN 51130**

**Colours:** **Ribbed carpet:** standard: light grey, anthracite, beige, blue; special colours available: mauve, blue/grey, red, brown, turquoise, royal blue, sand and grape; refer to p. 22  
**Types 510 R and 510 RK:** only standard colours available; refer to p. 22  
**Brush strip:** light grey, black

**Fire protection:** **Type 517R, 522R and 527R:** Cfl-s1 in accordance with EN 13501 for ribbed carpet material on request, colors light grey and anthracite.



**Connection:** Plastic-coated steel cable

**Automatic door systems:** Profile clearance of 3 mm available as an option for automatic door systems, in accordance with DIN 18650

**DIN 18650**

**Full details:** [www.emco-bau.com](http://www.emco-bau.com)

Type	Standard profile clearance <sup>1)</sup> approx. (mm)	Approx. height (mm)	Weight (kg/m <sup>2</sup> )	Installation frame <sup>3)</sup>			Accessories <sup>4)</sup>						
				Frame type	Dimensions in mm (H x W x D)	Material	LUMINA frame	INOX	Ramp edge	Cover strip	T-profile	Dirt collection well	Substructure
510 R	5	10	8,9	500/13	15,5 x 25 x 3	Aluminium		✓	✓	✓			
510 RK	5	10	10,8										
517 R	5	17	9,2	500/20	20 x 30 x 3 20 x 25 x 3	Aluminium Stainless steel <sup>2)</sup>		✓	✓	✓	✓		
517 R EN 16005	3	17	9,8										
517 RB	5	17	10,1										
517 RK	5	17	10,3										
522 R	5	22	10,0	500/25	25 x 28 x 3 25 x 25 x 3 25 x 30 x 3	Aluminium Natural brass Stainless steel <sup>2)</sup>		✓	✓	✓	✓		
522 R EN 16005	3	22	10,7				✓	✓	✓	✓			
522 RB	5	22	11,8										
522 RK	5	22	12,3										
527 R	5	27	10,5	500/30	30 x 30 x 3 30 x 30 x 3 30 x 25 x 3	Aluminium Natural brass Stainless steel <sup>2)</sup>		✓		✓			
527 R EN 16005	3	27	11,3										
527 RK	5	27	13,0										

Mat divisions as per factory standards, see p. 83  
Load specifications see p. 84

<sup>1)</sup> Rubber spacers

<sup>2)</sup> Stainless steel, material no. 1.4301 (V2A)

<sup>3)</sup> For details of installation frames, see p. 70  
For surcharges on mats requiring curved designs, cut-outs and angled designs, see p. 82-83

<sup>4)</sup> For details of accessories, see p. 70-79

emco DIPLOMAT with ribbed carpet insert (R)



**510 R**

Load-bearing capability:  
Normal

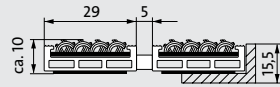

**517 R**

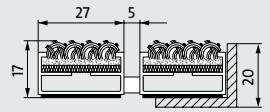

**522 R**

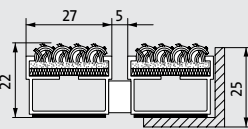

**527 R**

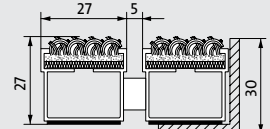

emco DIPLOMAT with ribbed carpet insert and brush strip (RB)

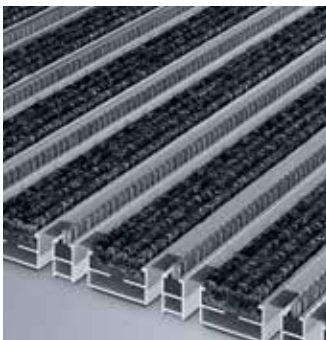

**517 RB**

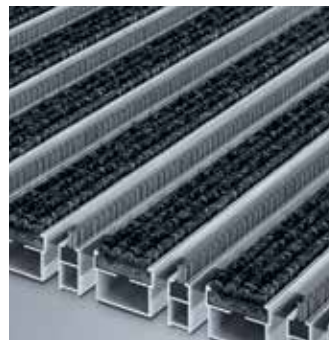
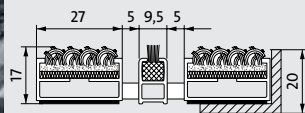

**522 RB**

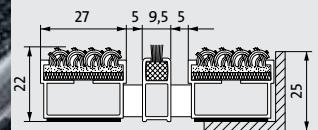

emco DIPLOMAT with ribbed carpet insert and scraper bar (RK)

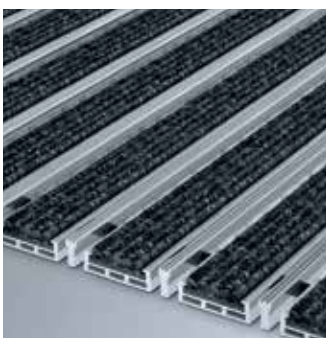

**510 RK**

Load-bearing capability:  
Normal

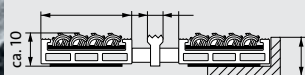

**517 RK**

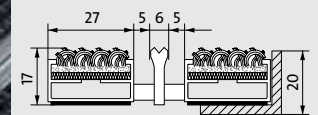

**522 RK**

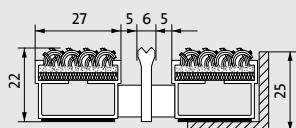

**527 RK**

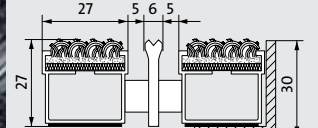

A weather-proof solution for residential buildings, administrative buildings and business premises with average numbers of visitors. Particularly suitable for picking up coarse dirt (zone 1).



# emco DIPLOMAT

## with rubber insert

- Recommended for:** Outdoor/indoor areas
- Load-bearing capacity:** Normal to heavy
- Description:** Roll-up, hard-wearing entrance mat for laying on the floor. Mats produced to fit width and walking depth specifications perfectly, without the need for adjustment profiles. Any geometric shape is available.
- Passages:** Up to 2000 passages/day (type 510 G and 510 GK up to 800 passages/day)
- Suitability for wheeled traffic:** Wheelchairs, (shopping trolleys), hand trolleys
- Support chassis:** Made from rigid aluminium with sound insulation underlay
- Tread surface:** Recessed, robust, weather-proof, profiled rubber inserts.  
Type GB: With additional brush strips mounted between the profiles  
Type GK: With additional scraper bars mounted between the profiles

**Non-slip properties:** R 9 slip resistance as per DIN 51130

**DIN 51130**

**Colours:**

**Brush strip:** light grey, black



**Rubber:** black



**Fire protection:** **Type 517G, 522G and 527G:** Complete mat system available with fire classification Cfl-s1 in accordance with EN 13501 (tested by the Textiles & Flooring Institute GmbH).



**Connection:** Plastic-coated steel cable

**Automatic door systems:** Profile clearance of 3 mm available as an option for automatic door systems, in accordance with DIN 18650

**DIN 18650**

**Full details:** [www.emco-bau.com](http://www.emco-bau.com)

Type	Standard profile clearance <sup>1)</sup> approx. (mm)	Approx. height (mm)	Weight (kg/m <sup>2</sup> )	Installation frame <sup>3)</sup>			Accessories <sup>4)</sup>							
				Frame type	Dimensions in mm (H x W x D)	Material	LUMINA frame	INOX	Ramp edge	Cover strip	T-profile	Dirt collection well	Substructure	
510 G	5	10	11,5	500/13	15,5 x 25 x 3	Aluminium		✓	✓	✓				
510 GK	5	10	12,8											
517 G	5	17	14,4	500/20	20 x 30 x 3 20 x 25 x 3	Aluminium Stainless steel <sup>2)</sup>		✓	✓	✓	✓			
517 G EN 16005	3	17	15,5											
517 GB	5	17	15,2											
517 GK	5	17	16,5											
522 G	5	22	14,3	500/25	25 x 28 x 3 25 x 25 x 3 25 x 30 x 3	Aluminium Natural brass Stainless steel <sup>2)</sup>		✓	✓	✓	✓			
522 G EN 16005	3	22	15,3											
522 GB	5	22	14,9											
522 GK	5	22	15,7											
527 G	5	27	17,0	500/30	30 x 30 x 3 30 x 30 x 3 30 x 25 x 3	Aluminium Natural brass Stainless steel <sup>2)</sup>		✓		✓				
527 G EN 16005	3	27	18,1											
527 GK	5	27	17,1											

Mat divisions as per factory standards, see p. 83  
Load specifications see p. 84

<sup>1)</sup> Rubber spacers

<sup>2)</sup> Stainless steel, material no. 1.4301 (V2A)

<sup>3)</sup> For details of installation frames, see p. 70  
For surcharges on mats that have curved designs, cut-outs and angled designs, see p. 82-83

<sup>4)</sup> For details of accessories, see p. 70-79

emco DIPLOMAT with rubber insert (G)

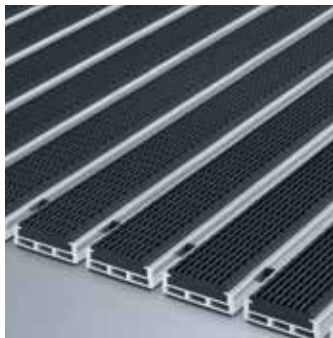

**510 G**

Load-bearing capability:  
Normal

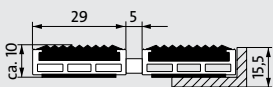

**517 G**

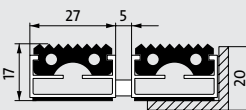

**522 G**

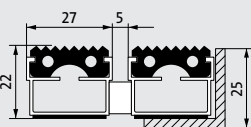

**527 G**

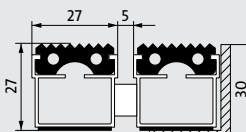

emco DIPLOMAT with rubber insert and brush strip (GB)



**517 GB**

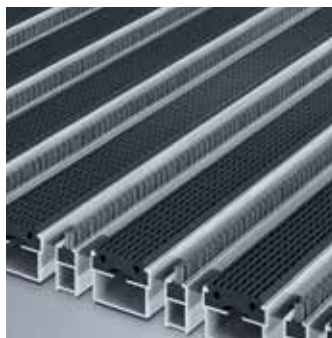
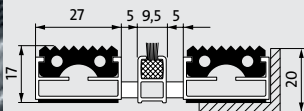

**522 GB**

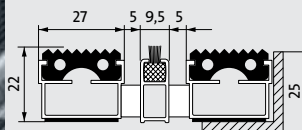

emco DIPLOMAT with rubber insert and scraper bar (GK)



**510 GK**

Load-bearing capability:  
Normal

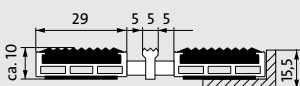

**517 GK**

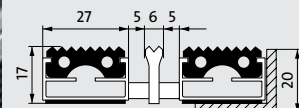

**522 GK**

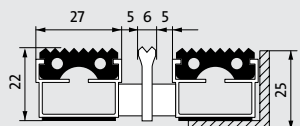

**527 GK**

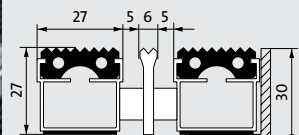

Frequent cleaning programme required for extra large quantities of coarse dirt (zone 1). For residential buildings, administrative buildings and business premises with average numbers of visitors.



# emco DIPLOMAT

## with cassette brush with cassette brush and rubber insert

- Recommended for:** Outdoor areas
- Load-bearing capacity:** Normal to heavy
- Description:** Roll-up, hard-wearing entrance mat for laying on the floor. Mats produced to fit width and walking depth specifications perfectly, without the need for adjustment profiles. Any geometric shape is available; can be cut through the bristle bundles if necessary.
- Passages:** Up to 2000 passages/day (type 510 CB up to 400 passages/day)
- Suitability for wheeled traffic:** Wheelchairs, hand trolleys
- Support chassis:** Made from rigid aluminium with sound insulation underlay
- Tread surface:** Robust, weather-proof, inset cassette sections, fitted with brush bundles arranged parallel to one another, or profiled rubber inserts combined with cassette sections

**Non-slip properties:** R 9 (rubber insert) and R 13 (cassette brushes) slip resistance as per DIN 51130

**DIN 51130**

**Colours**

**Cassette brush:** grey, black



**Rubber:** black



**Fire protection:** Complete mat system (only 517, 522 and 527 with black brush bundles) available with fire classification Cfl-s1 in accordance with EN 13501 (tested by the Textiles & Flooring Institute GmbH).



**Connection:** Plastic-coated steel cable

**Automatic door systems:** Profile clearance of 3 mm available as an option for automatic door systems, in accordance with DIN 18650

**DIN 18650**

**Full details:** [www.emco-bau.com](http://www.emco-bau.com)

Type	Standard profile clearance <sup>1)</sup> approx. (mm)	Approx. height (mm)	Weight (kg/m <sup>2</sup> )	Installation frame <sup>3)</sup>			Accessories <sup>4)</sup>						
				Frame type	Dimensions in mm (H x W x D)	Material	LUMINA frame	INOX	Ramp edge	Cover strip	T-profile	Dirt collection well	Substructure
510 CB	5	10 <sup>5)</sup>	11,5	500/13	15,5 x 25 x 3	Aluminium		✓	✓	✓			
510 GCB	5	10 <sup>5)</sup>	11,1										
517 CB	5	17 <sup>5)</sup>	11,6	500/20	20 x 30 x 3	Aluminium Stainless steel <sup>2)</sup>		✓	✓	✓	✓		
517 GCB	5	17 <sup>5)</sup>	13,7		20 x 25 x 3								
522 CB	5	22 <sup>5)</sup>	12,5	500/25	25 x 28 x 3	Aluminium Natural brass Stainless steel <sup>2)</sup>		✓	✓	✓	✓		
522 GCB	5	22 <sup>5)</sup>	14,0		25 x 25 x 3		✓	✓	✓	✓	✓		
					25 x 30 x 3								
527 CB	5	27 <sup>5)</sup>	14,5	500/30	30 x 30 x 3	Aluminium Natural brass Stainless steel <sup>2)</sup>		✓		✓			
527 GCB	5	27 <sup>5)</sup>	15,8		30 x 30 x 3			✓		✓			
					30 x 25 x 3								

Mat divisions as per factory standards, see p. 83  
Load specifications see p. 84

<sup>1)</sup> Rubber spacers

<sup>5)</sup> Actual mat height for CB insert: + 1 to 2 mm

<sup>2)</sup> Stainless steel, material no. 1.4301 (V2A)

<sup>3)</sup> For details of installation frames, see p. 70

For surcharges on mats that have curved designs, cut-outs and angled designs, see p. 82-83

<sup>4)</sup> For details of accessories, see p. 70-79



emco DIPLOMAT with cassette brush (CB)



**510 CB**

Load-bearing capability:  
Normal

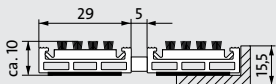

**517 CB**

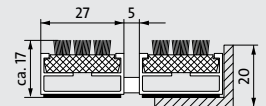

**522 CB**

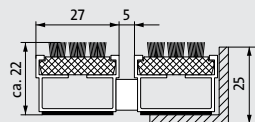

**527 CB**

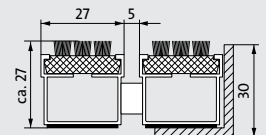

emco DIPLOMAT with rubber insert and cassette brush (GCB)

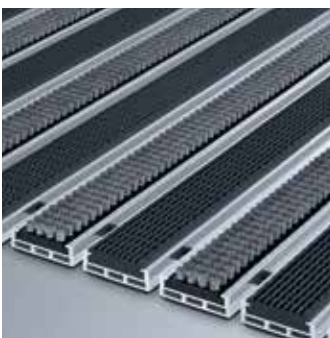

**510 GCB**

Load-bearing capability:  
Normal

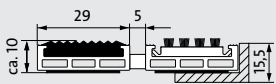

**517 GCB**

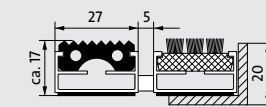

**522 GCB**

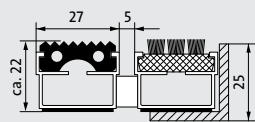

**527 GCB**

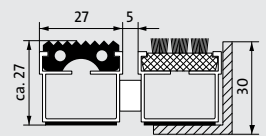

A great all-rounder for zones 1 and 2. For residential buildings, administrative buildings and business premises with average numbers of visitors. Suitable for picking up coarse and fine dirt.



# emco DIPLOMAT

with ribbed carpet insert and cassette brush  
with ribbed carpet and rubber insert

**Recommended for:** Indoor and covered outdoor areas

**Load-bearing capacity:** Normal to heavy

**Description:** Roll-up, hard-wearing entrance mat for laying on the floor. Mats produced to fit width and walking depth specifications perfectly, without the need for adjustment profiles. Any geometric shape is available; with type RCB, can be cut through the bristle bundles if necessary.

**Passages:** Up to 2000 passages/day (type 510 RCB and 510 RG up to 400 passages/day)

**Suitability for wheeled traffic:** Wheelchairs, (shopping trolleys), hand trolleys

**Support chassis:** Made from rigid aluminium with sound insulation underlay

**Tread surfaces:** Recessed, robust, weather-proof ribbed carpet strips, combined with  
Type RCB: Cassette sections, equipped with bristle bundles arranged parallel to one another  
Type RG: Profiled rubber inserts

**Non-slip properties:** R 10 (ribbed carpet/rubber) slip resistance as per DIN 51130

**DIN 51130**

**Colours:**

**Ribbed carpet:** standard: light grey, anthracite, beige, blue; special colours available: mauve, blue/grey, red, brown, turquoise, royal blue, sand and grape; refer to p. 22

**Type 510 RCB and 510 RG:** only standard colours available; refer to p. 22

**Cassette brush:** grey, black

**Rubber:** black

**Connection:** Plastic-coated steel cable

**Automatic door systems:** Profile clearance of 3 mm available as an option for automatic door systems, in accordance with DIN 18650

**DIN 18650**

**Full details:** [www.emco-bau.com](http://www.emco-bau.com)

Type	Standard profile clearance <sup>1)</sup> approx. (mm)	Approx. height (mm)	Weight (kg/m <sup>2</sup> )	Installation frame <sup>3)</sup>			Accessories <sup>4)</sup>						
				Frame type	Dimensions in mm (H x W x D)	Material	LUMINA frame	INOX	Ramp edge	Cover strip	T-profile	Dirt collection well	Substructure
510 RCB	5	10 <sup>5)</sup>	9,8	500/13	15,5 x 25 x 3	Aluminium		✓	✓	✓			
510 RG	5	10	10,2										
517 RCB	5	17 <sup>5)</sup>	10,6	500/20	20 x 30 x 3	Aluminium Stainless steel <sup>2)</sup>		✓	✓	✓	✓		
517 RG	5	17	11,8		20 x 25 x 3								
522 RCB	5	22 <sup>5)</sup>	11,7	500/25	25 x 28 x 3	Aluminium Natural brass Stainless steel <sup>2)</sup>							
522 RG	5	22	12,2		25 x 25 x 3		✓	✓	✓	✓	✓		
					25 x 30 x 3								
527 RCB	5	27 <sup>5)</sup>	12,3	500/30	30 x 30 x 3	Aluminium Natural brass Stainless steel <sup>2)</sup>							
					30 x 30 x 3			✓		✓			
527 RG	5	27	13,8		30 x 25 x 3								

Mat divisions as per factory standards, see p. 83  
Load specifications see p. 84

<sup>1)</sup> Rubber spacers

<sup>5)</sup> Actual mat height for CB insert: + 1 to 2 mm

<sup>2)</sup> Stainless steel, material no. 1.4301 (V2A)

<sup>3)</sup> For details of installation frames, see p. 70  
For surcharges with mats that have curved designs, cut-outs and angled designs, see p. 82-83

<sup>4)</sup> For details of accessories, see p. 70-79





emco DIPLOMAT with ribbed carpet insert and cassette brush (RCB)



**510 RCB**

Load-bearing capacity:  
Normal

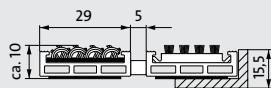

**517 RCB**

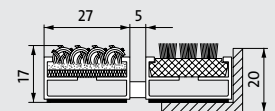

**522 RCB**

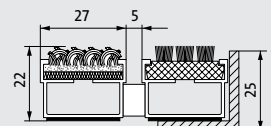

**527 RCB**

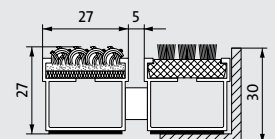

emco DIPLOMAT with ribbed carpet and rubber insert (RG)



**510 RG**

Load-bearing capability:  
Normal

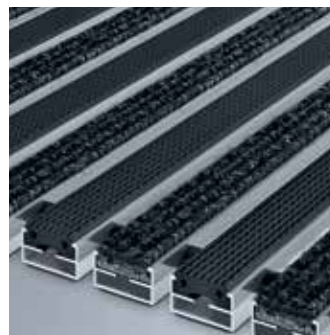
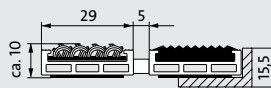

**517 RG**

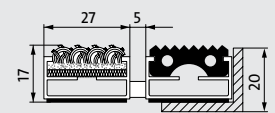

**522 RG**

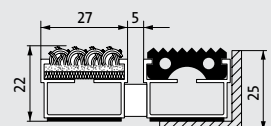

**527 RG**

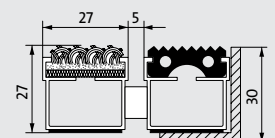

A stylish solution with a carpet-like appearance. For all buildings with average numbers of visitors and requiring a tailored look. Ideal for picking up fine dirt.



# emco DIPLOMAT

## with MAXIMUS insert

- Recommended for:** Indoor areas
- Load-bearing capacity:** Normal
- Description:** Roll-up, hard-wearing entrance mat for laying on the floor. Mats produced to fit width and walking depth specifications perfectly, without the need for adjustment profiles. Any geometric shape is available.
- Passages:** Up to 1000 passages/day
- Suitability for wheeled traffic:** Wheelchairs, shopping trolleys, hand trolleys
- Support chassis:** Made from rigid aluminium with sound insulation underlay
- Tread surfaces:** Recessed, robust MAXIMUS inserts (clean-off floor covering made using a unique 100% polyamide fibre)

**Colours:** 12 standard MAXIMUS colours/standard designs (single and patterned): black, anthracite, grey, brown and beige. Single: blue and red.

**Fire protection:** Inserts with fire classification Bfl-s1 in accordance with EN 13501 (tested by the Textiles & Flooring Institute GmbH).



**Connection:** Plastic-coated steel cable

**Automatic door systems:** Profile clearance of 3 mm available as an option for automatic door systems, in accordance with DIN 18650

**DIN 18650**

**Full details:** [www.emco-bau.com](http://www.emco-bau.com)

Type	Standard profile clearance <sup>1)</sup> approx. (mm)	Approx. height (mm)	Weight (kg/m <sup>2</sup> )	Installation frame <sup>3)</sup>			Accessories <sup>4)</sup>						
				Frame type	Dimensions in mm (H x W x D)	Material	LUMINA frame	INOX	Ramp edge	Cover strip	T-profile	Dirt collection well	Substructure
517 M	5	17	9,2	500/20	20 x 30 x 3	Aluminium							
					20 x 25 x 3	Stainless steel <sup>2)</sup>	✓	✓	✓	✓			
522 M	5	22	10,0	500/25	25 x 28 x 3	Aluminium							
					25 x 25 x 3	Natural brass	✓	✓	✓	✓			
					25 x 30 x 3	Stainless steel <sup>2)</sup>							
527 M	5	27	10,5	500/30	30 x 30 x 3	Aluminium							
					30 x 30 x 3	Natural brass		✓	✓				
					30 x 25 x 3	Stainless steel <sup>2)</sup>							

Mat divisions as per factory standards, see p. 83

Load specifications see p. 84

<sup>1)</sup> Rubber spacers

<sup>2)</sup> Stainless steel, material no. 1.4301 (V2A)

<sup>3)</sup> For details of installation frames, see p. 70

For surcharges with mats that have curved designs, cut-outs and angled designs, see p. 82-83

<sup>4)</sup> For details of accessories, see p. 70-79

**Colours:**

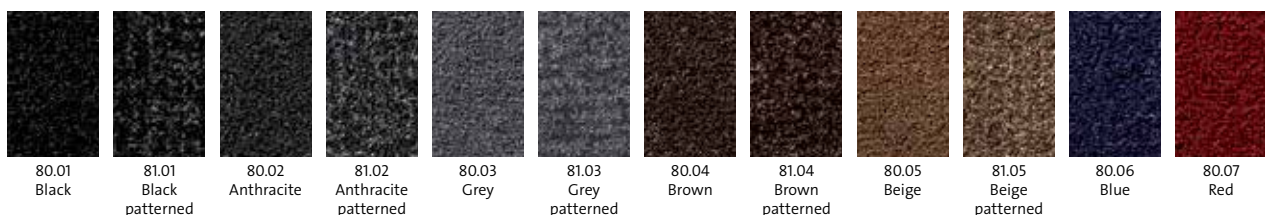



emco DIPLOMAT with MAXIMUS insert (M)



517 M

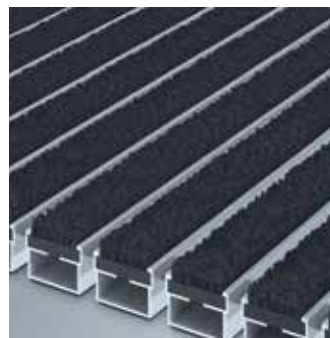
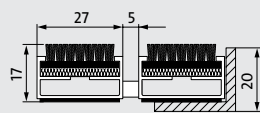

522 M

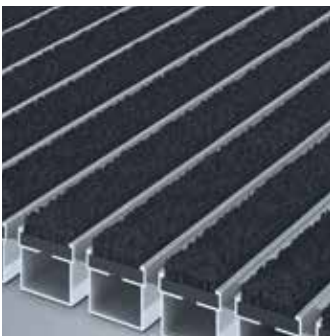
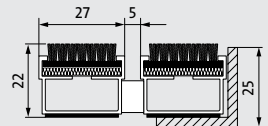

527 M

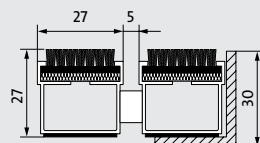



emco **MARSCHALL**  
emco **PLAZA**



**Ideal for very/exceptionally heavily frequented buildings**



Very heavy



Exceptionally heavy



In zone 1 and zone 2, emco products MARSCHALL and PLAZA ensure indoor areas are kept clean and create a harmonious overall impression. Here, fine dirt is collected using ribbed carpet inserts, which can be combined with rubber inserts, textile brushes or brush strips if required. The emco ribbed carpet inserts can be replaced with the utmost ease.

*Zone 2, indoor area: emcoMARSCHALL*

Hard-wearing entrance mat systems for very heavily frequented buildings such as shopping centres and airports. Ideal for picking up coarse and/or fine dirt.



# emco **MARSCHALL**

- Recommended for:** Indoor and covered outdoor areas
- Load-bearing capacity:** Very heavy
- Description:** Roll-up, extremely hard-wearing entrance mat for supported or self-supporting laying. Can be rolled over and also driven over. Mats produced to fit width and walking depth specifications perfectly, without the need for adjustment profiles. Any geometric shape is available. With type RCB, can be cut through the bristle bundles if necessary.
- Passages:** From 2000 passages/day
- Suitability for wheeled traffic:** Wheelchairs, (shopping trolleys), hand trolleys, cars, (pallet trucks)
- Support chassis:** Reinforced support chassis, made rigid aluminium with sound insulation underlay
- Tread surfaces:** Recessed, robust, weather-proof coarse fibre ribbed carpet strips (brand-name fibres) for even better dirt removal  
Type RG: Combined with profiled rubber inserts,  
Type RCB: Combined with cassette sections, equipped with bristle bundles arranged parallel to one another

**Non-slip properties:** R 9 (rubber insert), R 10 (rubber and ribbed carpet insert), R 11 (ribbed carpet insert)

**DIN 51130**

**Colours:**

**Ribbed carpet:** standard: light grey, anthracite, beige, blue; special colours available: mauve, blue/grey, red, brown, turquoise, royal blue, sand and grape; refer to p. 22

**Rubber:** black

**Cassette brush:** grey, black

**Fire protection:**



**Type 517 S/R and 522 S/R:** Cfl-s1 in accordance with EN 13501 for ribbed carpet material on request, colors light grey and anthracite.

**Connection:**

Plastic-coated steel cable

**Automatic door systems:**

Profile clearance of 3 mm available as an option for automatic door systems, in accordance with DIN 18650

**DIN 18650**

**Full details:** [www.emco-bau.com](http://www.emco-bau.com)

Type	Standard profile clearance <sup>1)</sup> approx. (mm)	Approx. height (mm)	Weight (kg/m <sup>2</sup> )	Installation frame <sup>3)</sup>			Accessories <sup>4)</sup>							
				Frame type	Dimensions in mm (H x W x D)	Material	LUMINA frame	INOX	Ramp edge	Cover strip	T-profile	Dirt collection well-fangwanne	Substructure	
517 S/R	5	17	12,7	500/20	20 x 30 x 3 20 x 25 x 3	Aluminium Stainless steel <sup>2)</sup>								
522 S/R EN 16005	3	22	15,5							✓	✓	✓	✓	
517 S/RG	5	17	14,7											
517 S/RCB	5	17 <sup>5)</sup>	14,0											
522 S/R	5	22	15,0	500/25	25 x 28 x 3 25 x 25 x 3 25 x 30 x 3	Aluminium Natural brass Stainless steel <sup>2)</sup>								
522 S/R EN 16005	3	22	15,5				✓			✓	✓	✓	✓	
522 S/RG	5	22	18,0											
522 S/RCB	5	22 <sup>5)</sup>	17,5											

Mat divisions as per factory standards, see p. 83  
Load specifications see p. 84

<sup>1)</sup> Rubber spacers

<sup>5)</sup> Actual mat height for CB insert: + 1 to 2 mm

<sup>2)</sup> Stainless steel, material no. 1.4301 (V2A)

<sup>3)</sup> For details of installation frames, see p. 70  
For surcharges with mats that have curved designs, cut-outs and angled designs, see p. 82-83

<sup>4)</sup> For details of accessories, see p. 70-79



emco MARSCHALL with ribbed carpet insert (R)

Coarse fibre  
ribbed carpet



517 S/R

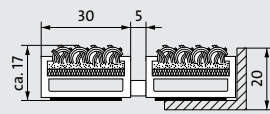

522 S/R

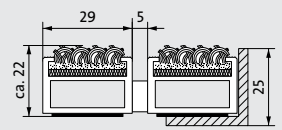

emco MARSCHALL with ribbed carpet and rubber insert (RG)

Coarse fibre  
ribbed carpet



517 S/RG

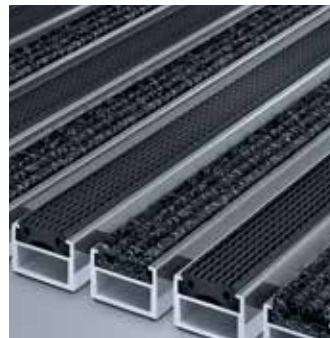
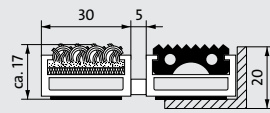

522 S/RG

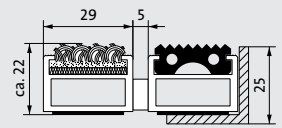

emco MARSCHALL with ribbed carpet insert and cassette brush (RCB)

Coarse fibre  
ribbed carpet



517 S/RCB

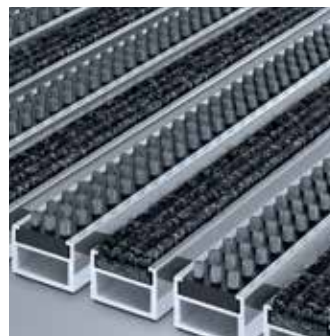
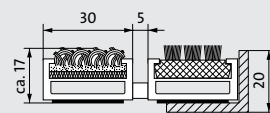

522 S/RCB

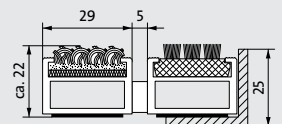

A weather-proof option from the range of robust solutions, extra-effective against coarse dirt (zone 1).  
For very heavily frequented buildings.



# emco MARSCHALL

**Recommended for:** Outdoor areas

**Load-bearing capacity:** Very heavy

**Description:** Roll-up, extremely hard-wearing entrance mat for supported or self-supporting laying. Can be rolled over and also driven over. Mats produced to fit width and walking depth specifications perfectly, without the need for adjustment profiles. Any geometric shape is available. With types CB and GCB, can be cut through the bristle bundles if necessary.

**Passages:** From 2000 passages/day

**Suitability for wheeled traffic:** Wheelchairs, (shopping trolleys), hand trolleys, cars, pallet trucks

**Support chassis:** Reinforced support chassis, made from rigid aluminium with sound insulation underlay

**Tread surfaces:** Recessed, robust, weather-proof, profiled rubber inserts and/or cassette sections, equipped with bristle bundles arranged parallel to one another.

**Non-slip properties:** R 9 (rubber insert) and R 13 (cassette brushes) slip resistance as per DIN 51130

**DIN 51130**

**Colours:**

**Rubber:** black  
**Cassette brush:** grey, black

**Fire protection:** **Type 517 S/G and 522 S/G:** Complete mat system available with fire classification Cfl-s1 in accordance with EN 13501.



**Type 517 S/CB and 522 S/CB:** Complete mat system (only with black brush bundles) available with fire classification Cfl-s1 in accordance with EN 13501 (tested by the Textiles & Flooring Institute GmbH).

**Connection:** Plastic-coated steel cable

**Automatic door systems:** Profile clearance of 3 mm available as an option for automatic door systems, in accordance with DIN 18650

**DIN 18650**

**Full details:** [www.emco-bau.com](http://www.emco-bau.com)

Type	Standard profile clearance <sup>1)</sup> approx. (mm)	Approx. height (mm)	Weight (kg/m <sup>2</sup> )	Installation frame <sup>3)</sup>			Accessories <sup>4)</sup>							
				Frame type	Dimensions in mm (H x W x D)	Material	LUMINA frame	INOX	Ramp edge	Cover strip	T-profile	Dirt collection well	Substructure	
517 S/G	5	17	16,8	500/20	20 x 30 x 3	Aluminium								
517 S/G EN 16005	3	17	17,4							✓	✓	✓	✓	
517 S/CB	5	17 <sup>5)</sup>	15,3			20 x 25 x 3	Stainless steel <sup>2)</sup>							
517 S/GCB	5	17 <sup>5)</sup>	16,0											
522 S/G	5	22	21,0	500/25	25 x 28 x 3	Aluminium								
522 S/G EN 16005	3	22	21,7											
522 S/CB	5	22 <sup>5)</sup>	18,5			25 x 25 x 3	Natural brass	✓						
522 S/GCB	5	22 <sup>5)</sup>	20,5			25 x 30 x 3	Stainless steel <sup>2)</sup>							

Mat divisions as per factory standards, see p. 83

Load specifications see p. 84

<sup>1)</sup> Rubber spacers

<sup>5)</sup> Actual mat height for CB insert: + 1 to 2 mm

<sup>2)</sup> Stainless steel, material no. 1.4301 (V2A)

<sup>3)</sup> For details of installation frames, see p. 70

For surcharges with mats that have curved designs, cut-outs and angled designs, see p. 82-83

<sup>4)</sup> For details of accessories, see p. 70-79





emco MARSCHALL with rubber insert (G)

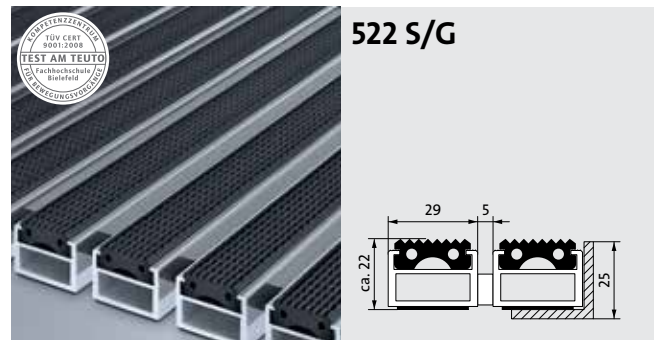
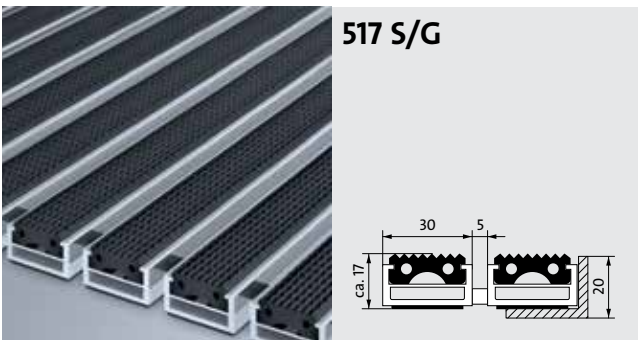

emco MARSCHALL with cassette brush (CB)

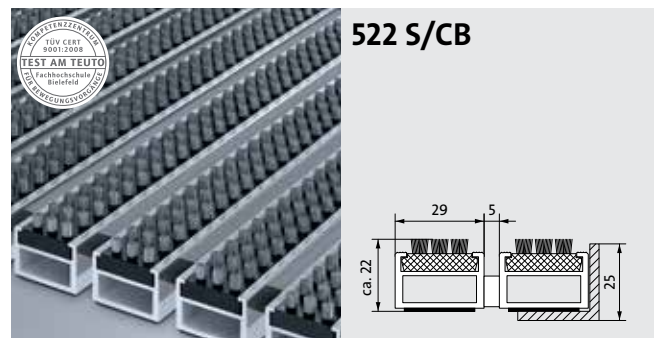
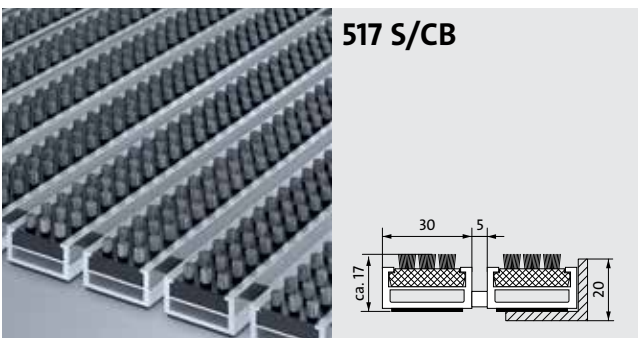

emco MARSCHALL with rubber insert and cassette brush (GCB)

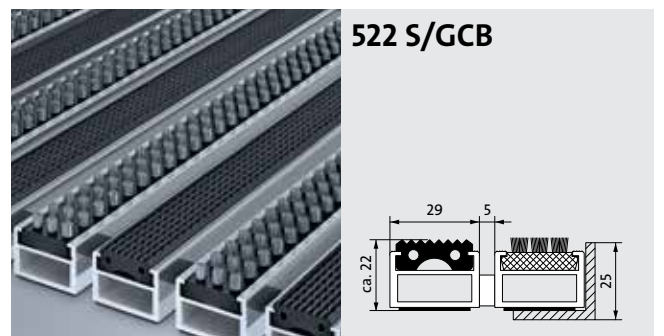
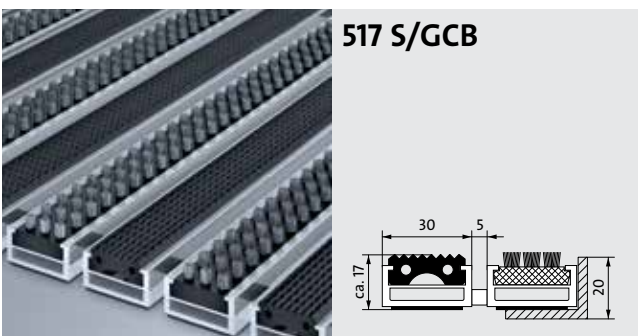

The toughest of all the robust entrance mat systems available.  
For exceptionally heavily frequented buildings such as shopping centres and airports. For increased collection of coarse and fine dirt.



# emco PLAZA

- Recommended for:** Outdoor areas:  
Types 542 S/G, 542 S/CB and 542 S/GCB  
Indoor and covered outdoor areas:  
Types 542 S/R, 542 S/RG and 542 S/RCB
- Load-bearing capacity:** Exceptionally heavy
- Description:** Roll-up, extremely hard-wearing entrance mat for heavy loads; for supported or self-supporting laying. Can be rolled over and also driven over by pallet trucks and goods vehicles. The special profile shape and height enable more dirt to be collected between the profiles. Mats produced to fit width and walking depth specifications perfectly, without the need for adjustment profiles. Any geometric shape is available; with types S/CB, S/RCB and S/GCB, can be cut through the bristle bundles if necessary.
- Passages:** From 5000 passages/day
- Suitability for wheeled traffic:** Wheelchairs, (shopping trolleys), hand trolleys, pallet trucks, cars, HGVs (up to 7.5 t)
- Support chassis:** Thick-walled, rigid aluminium with sound insulation underlay
- Tread surfaces:** Recessed, robust, weather-proof coarse fibre ribbed carpet strips (brand-name fibres) for even better dirt removal, profiled rubber inserts and/or cassette sections, equipped with bristle bundles arranged parallel to one another.

**Non-slip properties:** R 9 (rubber insert), R 10 (ribbed carpet and rubber insert), R 11 (ribbed carpet insert), R 13 (cassette brushes) slip resistance

**DIN 51130**

**Colours:**

**Rubber:** black  
**Cassette brush:** grey, black  
**Ribbed carpet:** standard: light grey, anthracite, beige, blue; special colours available: mauve, blue/grey, red, brown, turquoise, royal blue, sand and grape; refer to p. 22

**Fire protection:**



**Type 542 S/R:** Cfl-s1 in accordance with EN 13501 for ribbed carpet material on request, colors light grey and anthracite.  
**Type 542 S/G:** Complete mat system available with fire classification Cfl-s1 in accordance with EN 13501.  
**Type 542 S/CB:** Complete mat system (only with black brush bundles) available with fire classification Cfl-s1 in accordance with EN 13501 (tested by the Textiles & Flooring Institute GmbH).

**Connection:**

Plastic-coated steel cable

**Automatic door systems:**

Profile clearance of 3 mm available as an option for automatic door systems, in accordance with DIN 18650

**DIN 18650**

**Full details:** [www.emco-bau.com](http://www.emco-bau.com)

Type	Standard profile clearance <sup>1)</sup> approx. (mm)	Approx. height (mm)	Weight (kg/m <sup>2</sup> )
542 S/G	5	42	34,1
542 S/CB	5	42	27,7
542 S/GCB	5	42 <sup>3)</sup>	31,1
542 S/R	5	42	25,0
542 S/RG	5	42	29,3
542 S/RCB	5	42 <sup>3)</sup>	26,4

Installation frame <sup>3)</sup>		
Frame type	Dimensions in mm (H x W x D)	Material
500/46	47,5 x 35 x 4,5	Aluminium
	46 x 25 x 3	Stainless steel <sup>2)</sup>

Mat divisions as per factory standards, see p. 83

Load specifications see p. 84

<sup>1)</sup> Rubber spacers

<sup>3)</sup> Actual mat height for CB insert: + 1 to 2 mm

<sup>2)</sup> Stainless steel, material no. 1.4301 (V2A)

<sup>3)</sup> For details of installation frames, see p. 70

For surcharges with mats that have curved designs, cut-outs and angled designs, see p. 82-83



emco PLAZA with rubber insert (G)

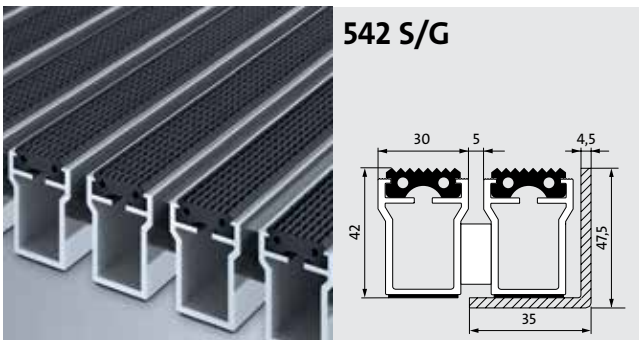

emco PLAZA with cassette brush (CB)

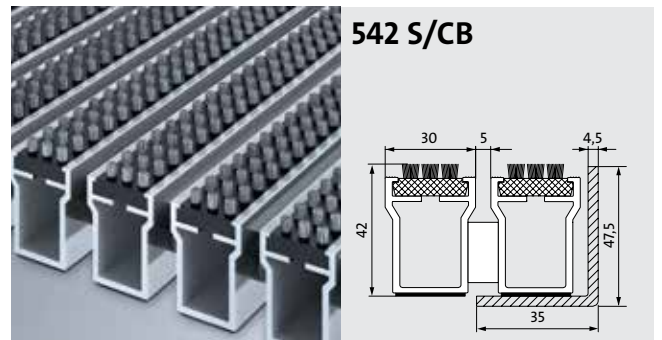

emco PLAZA with rubber insert and cassette brush (GCB)

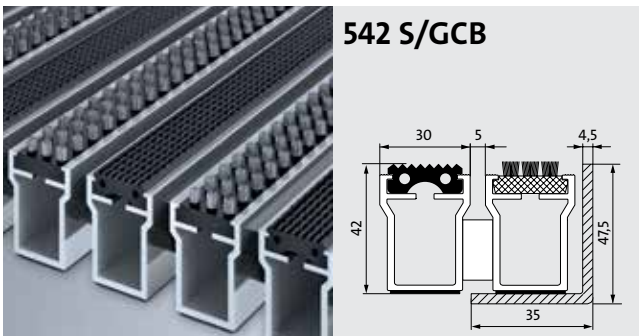

emco PLAZA with ribbed carpet insert (R)

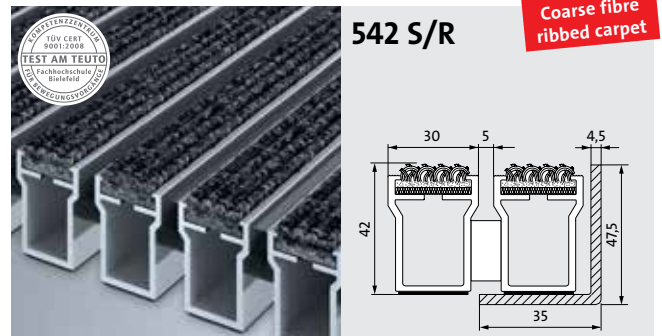

emco PLAZA with ribbed carpet and rubber insert (RG)

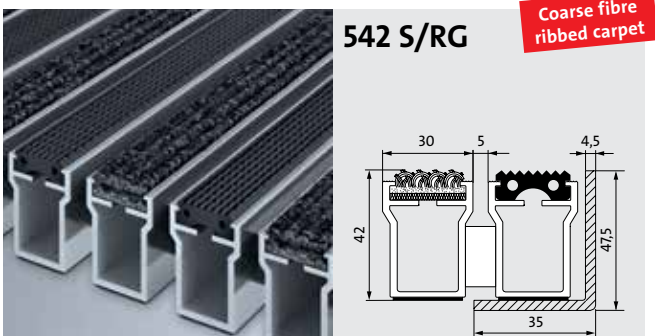

emco PLAZA with ribbed carpet insert and cassette brush (RCB)

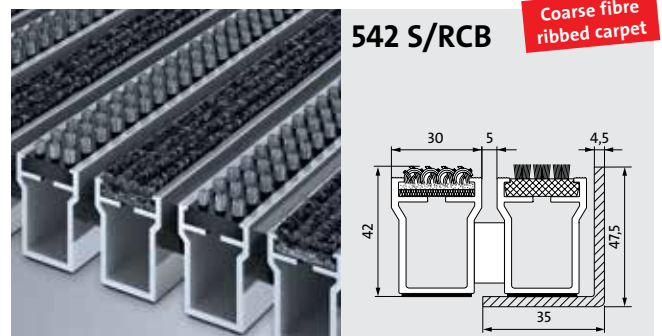



Ideal for **special**  
applications



emco **SENATOR**, emco **TLS**, emco **SPIN® SAFE**, emco **GS 17**, emco **KADETT** and emco **RADIAL**

emco has the right entrance mat to suit any requirement, in both indoor and covered outdoor areas. The extra-wide designs of the SENATOR options combine a harmonious appearance with excellent resilience. RADIAL is the ideal solution for entrance areas that make a real architectural impact and feature rounded designs. GS17, meanwhile, is an alternative system with a closed design that is suitable for very heavily frequented buildings such as shopping centres. Finally, KADETT represents a special solution for entrance areas with security tagging equipment.

*Zone 2, indoor area: emco RADIAL*

Extra-wide options for all buildings with high demands in terms of resilience and a harmonious look. Particularly suitable for picking up fine dirt (zone 2).



# emco SENATOR

with ribbed carpet insert  
with MAXIMUS insert and OUTDOOR insert

- Recommended for:** Indoor and covered outdoor areas
- Load-bearing capacity:** Type 522 W/SR: very heavy
- Description:** Roll-up, hard-wearing entrance mat with extra-wide profile bars, for laying on the floor. Mats produced to fit width and walking depth specifications perfectly, without the need for adjustment profiles. Any geometric shape is available.
- Passages:** Up to 2000 passages/day (type 522 M up to 1000 passages/day, type 522 WS from 2000 passages/day)
- Suitability for wheeled traffic:** Wheelchairs, (shopping trolleys), hand trolleys  
Type W/SR: also cars and pallet trucks
- Support chassis:** Thick-walled, rigid aluminium with sound insulation underlay
- Tread surface:** Types R: Recessed, robust, weather-proof ribbed carpet strips  
Type RB/RK: With additional brush strips/scraper bars mounted between the profiles  
Type M/MI: Recessed, robust MAXIMUS inserts (clean-off floor covering made from 100% polyamide fibre)  
Type CB: Recessed, robust, weather-proof cassette brushes, equipped with bristle bundles arranged parallel to one another  
Type OUTDOOR: Recessed, robust, weather-proof Polypropylene insert. UV-resistance. Optimum brushing effect.

**Non-slip properties:** R 11 slip resistance as per DIN 51130

**DIN 51130**

**Colours:**

**Ribbed carpet:** standard: light grey, anthracite, beige, blue; special colours available: mauve, blue/grey, red, brown, turquoise, royal blue, sand and grape; refer to p. 22  
**Cassette brush:** grey, black  
**Brush strip:** grey, black  
**OUTDOOR:** anthracite, light grey, red  
**MAXIMUS:** 12 standard colours/standard designs (single and patterned): black, anthracite, grey, brown and beige. Single: blue and red.  
**Production of customised „logo mats in aluminium profile“ available.**

**Fire protection:**



**Type MAXIMUS:** Insert with fire classification Bfl-s1 in accordance with EN 13501 (tested by the Textiles & Flooring Institute GmbH).

**Connection:**

Plastic-coated steel cable

**Automatic door systems:**

Profile clearance of 3 mm available as an option for automatic door systems, in accordance with DIN 18650

**DIN 18650**

**Full details:** [www.emco-bau.com](http://www.emco-bau.com)

Type	Standard profile-clearance <sup>1)</sup> approx. (mm)	Approx. height (mm)	Weight (kg/m <sup>2</sup> )	Installation frame <sup>3)</sup>			Accessories <sup>4)</sup>							
				Frame-type	Dimensions in mm (H x W x D)	Material	LUMINA- frame	INOX	Ramp- edge	Cover- strip	T-profile	Dirt- collection well	Sub- structure	
522 W/R	5	22	10,6	500/25	25 x 28 x 3	Aluminium	✓	✓	✓	✓	✓			
522 WS/R	5	22	16,0				✓		✓	✓	✓	✓	✓	✓
522 W/RCB	5	22	11,6				✓	✓	✓	✓	✓			
522 WS/RCB	5	22	15,4				✓		✓	✓	✓	✓	✓	✓
522 W/RK	5	22	12,5				✓	✓	✓	✓	✓			
522 W/RB	5	22	13,0				✓	✓	✓	✓	✓			
522 W/M	5	22	10,6				✓	✓	✓	✓	✓			
522 W/MI	5	22	10,6				✓	✓	✓	✓	✓			
522 W/ OUTDOOR	5	22	11,0				✓	✓	✓	✓	✓			
522 WS/ OUTDOOR	5	22	16,0				✓		✓	✓	✓	✓	✓	✓

Mat divisions as per factory standards, see p. 83  
Load specifications see p. 84

<sup>1)</sup> Rubber spacers

<sup>2)</sup> Stainless steel, material no. 1.4301 (V2A)

<sup>3)</sup> For details of installation frames, see p. 70  
For surcharges with mats that have curved designs, cut-outs and angled designs, see p. 82-83

<sup>4)</sup> For details of accessories, see p. 70-79

emco SENATOR with wide ribbed carpet insert (R)

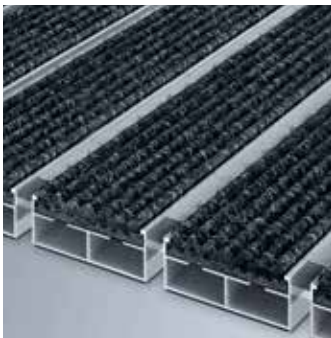

522 W/R

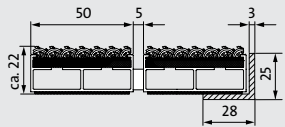

emco SENATOR reinforced profile with wide ribbed carpet insert (R)

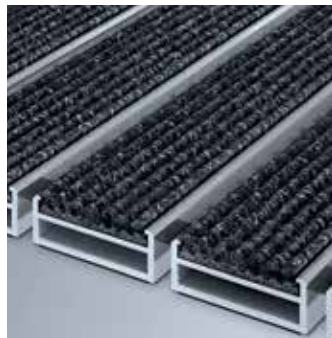

522 WS/R

Load-bearing capacity: Very heavy

also suitable for self-supporting laying

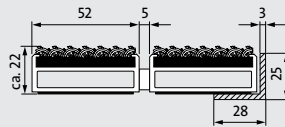

emco SENATOR with wide ribbed carpet insert and cassette brushes (RCB)



522 W/RCB

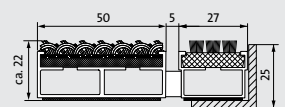

emco SENATOR with wide ribbed carpet insert and cassette brushes (RCB)

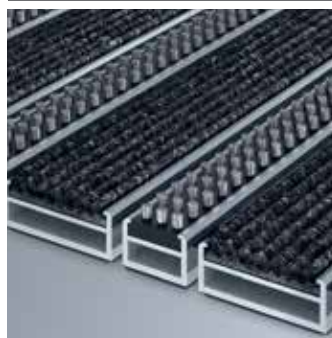

522 WS/RCB

Load-bearing capacity: Very heavy

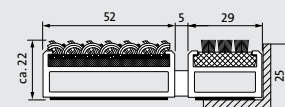

emco SENATOR with wide ribbed carpet insert and scraper bar (RK)

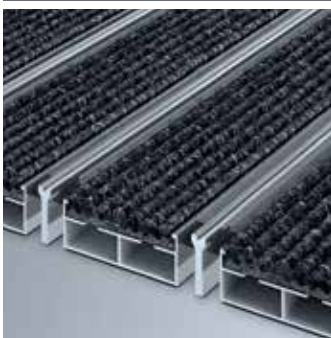

522 W/RK

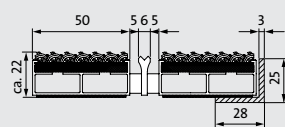

emco SENATOR with wide with ribbed carpet insert and brush strip (RB)

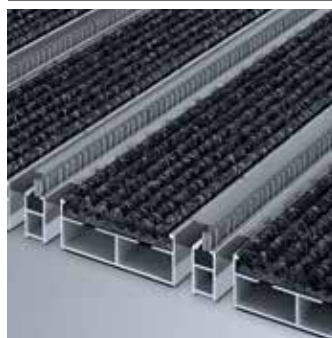

522 W/RB

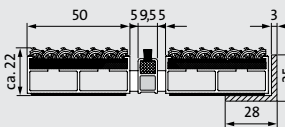

emco SENATOR MAXIMUS insert (M)

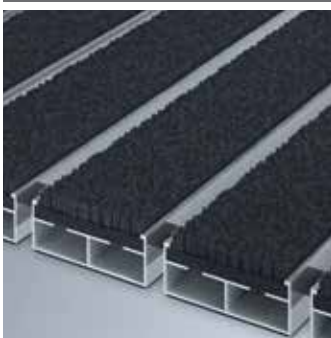

522 W/M

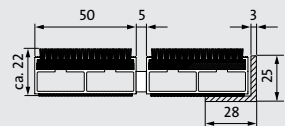

emco SENATOR IMAGE with MAXIMUS insert (MI)

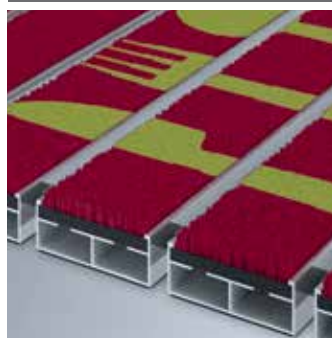

522 W/MI

Customised image printing option

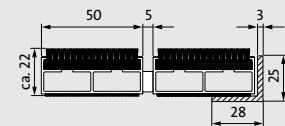

emco SENATOR with wide OUTDOOR insert (OUTDOOR)



522 W/  
OUTDOOR

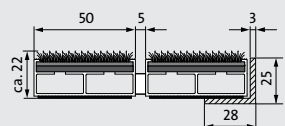

emco SENATOR with wide OUTDOOR insert (OUTDOOR)

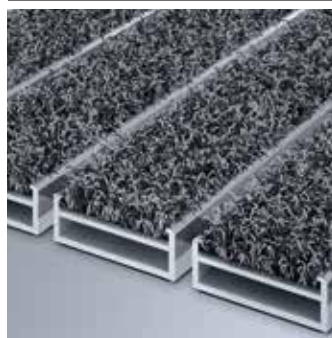

522 WS/  
OUTDOOR

Load-bearing capacity: Very heavy

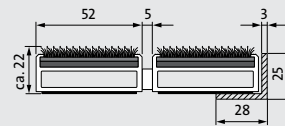

The entrance mat with a double function:  
Guidance system and cleaning for indoor and covered outdoor areas (zone 2)



# emco 522 TLS

## Guidance system for the visually impaired – combined in a system

**Recommended for:** Type G: Outdoor  
Type R: Indoor and covered outdoor areas

**Description:** The emco guidance system for the visually impaired provides a tactile surface that is available in high-contrast colours. With different profile heights and profiles that run both transversely and longitudinally to the direction of traffic, it enables blind and partially sighted people to find doors, stairs, lifts, etc., at the same time as providing orientation in larger areas. The guidance system also draws attention to obstacles and possible dangers, facilitating orientation for people with no visual impairment, too. Optional attention panel: ribbed flooring bonded onto an adjustment mat (anthracite).

**Height:** approx. 22 mm

**Passages:** DIPLOMAT: up to 2000 passages/day  
MARSCHALL: from 2000 passages/day

**Suitability for wheeled traffic:** Wheelchairs, (shopping trolleys), hand trolleys

**Support chassis:** Made rigid aluminium with sound insulation underlay. In the tactile guidance zone, the profiles are set in two alternating heights: 17 and 22 mm; optionally available in aluminium with coloured paint finish

**Tread surface:** Robust, weather-proof, inset ribbed carpet strips and/or profiled rubber inserts

**Non-slip properties:** R 11 (ribbed carpet) and R 9 (rubber insert)  
slip resistance as per DIN 51130

**DIN 51130**

**Colours:** **Ribbed carpet:** light grey, anthracite  
**Rubber inserts:** black  
**Aluminium support chassis:** white, black (optional)

**Connection:** Threaded steel rod

**Attention panel:** 350 x 350 mm up to 1000 x 1000 mm

**Technical details:** Please refer to the following pages for further technical details for the individual entrance mat systems:  
DIPLOMAT 522 R: s.p. 36  
DIPLOMAT 522 G: s.p. 38  
DIPLOMAT 522 RG: s.p. 42  
MARSCHALL 522 S/R: s.p. 52  
MARSCHALL 522 S/RG: s.p. 52  
MARSCHALL 522 S/G: s.p. 54

**Full details:** [www.emco-bau.com](http://www.emco-bau.com)

Product	Type	Insert	Standard profile-clearance <sup>1)</sup> approx. (mm)	Approx. height (mm)	Weight (kg/m <sup>2</sup> )	Installation frame <sup>2)</sup>			
						Frame-type	Dimensions in mm (H x W x D)	Material	
DIPLOMAT	522 TLS/R	ribbed carpet	3	22	9,6	500/25	25 x 28 x 3	Aluminium	
	522 TLS/G	rubber							14,0
	522 TLS R/G	ribbed carpet/rubber							9,6
MARSCHALL	522 TLS S/R	ribbed carpet	3	22	15,0	500/25	25 x 28 x 3	Aluminium	
	522 TLS S/G	rubber							14,4
	522 TLS S/RG	ribbed carpet/rubber							9,6

Mat divisions as per factory standards, see p. 83  
Load specifications see p. 84

<sup>1)</sup> Rubber spacers

<sup>2)</sup> For details of installation frames, see p. 70

For surcharges with mats that have curved designs, cut-outs and angled designs, s. p. 82-83

### emco DIPLOMAT with ribbed carpet insert TLS (R)

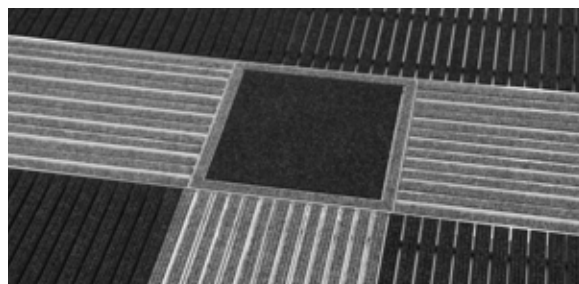

### 522 TLS/R

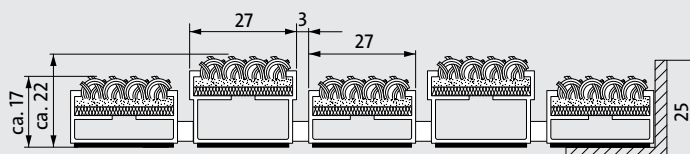



The guidance system for the blind in the emco entrance mat:  
high-quality and standard-compliant with stainless steel tiles  
for indoor and covered outdoor areas (zone 2)



# emco SPIN® SAFE

## Entrance mat combined with stainless steel elements in accordance with DIN 32984

**Recommended for:** Type G: Outdoor  
Type R: Indoor and covered outdoor areas

**Description:** The tactile floor-level information provided by the robust stainless steel elements corresponds to the standard DIN 32984, already well known in outdoor areas. The material offers strong contrasts for people with impaired vision. The auditory impression when using a cane also changes significantly. The integrated stainless steel tiles are available in narrow (122 mm) or wide (300 mm) versions (each has 3 aluminium profile bars, and can thus be rolled up). Mat is produced to fit perfectly in width; in depth, dimensions in increments of 100 mm are possible. Optionally available with dimpled tiles as an attention panel.

**Height:** 25,9 mm

**Passages:** SPIN® SAFE/G: from 2000 passages/day  
SPIN® SAFE/R: from 2000 passages/day

**Suitability for wheeled traffic:** Wheelchairs, (shopping trolleys), hand trolleys

**Support chassis:** Made rigid aluminium with sound insulation underlay

**Tread surface:** Robust, weather-proof, inset ribbed carpet strips (ribbed carpet strips) and/or profiled rubber inserts, combined with stainless steel tiles

**Non-slip properties:** R 9 (stainless steel tile), R 11 (ribbed carpet) and R 9 (rubber insert) slip resistance as per DIN 51130

**DIN 51130**

**Colours:** **Ribbed carpet:** anthracite  
**Rubber inserts:** black

**Connection:** Plastic-coated steel cable

**Attention panel:** 450 x 450 mm

**Full details:** [www.emco-bau.com](http://www.emco-bau.com)

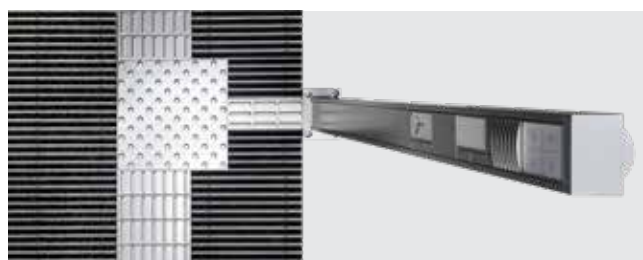

Product	Type	Insert	Standard profile-clearance <sup>1)</sup> approx. (mm)	Approx. height (mm)	Weight (kg/m <sup>2</sup> )	Installation frame <sup>2)</sup>		
						Frame-type	Dimensions in mm (H x W x D)	Material
SPIN® SAFE	22 SPIN/R	ribbed carpet	5	23,5	27,7	500/25	25 x 28 x 3	Aluminium
	22 SPIN/G	rubber						

Mat divisions as per factory standards, see p. 83  
Load specifications see p. 84

<sup>1)</sup> Rubber spacers

<sup>2)</sup> For details of installation frames, see p. 70

For surcharges with mats that have curved designs, cut-outs and angled designs, s.p. 82-83

### emco SPIN® SAFE with ribbed carpet insert (R)

**NEW!**



### 22 SPIN/R

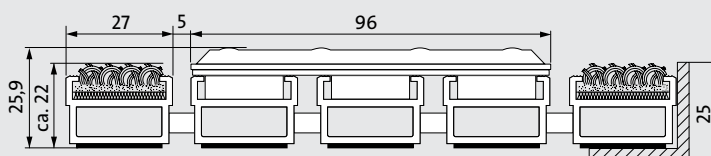

An unconventional option for buildings with real architectural impact. Ideal design for all entrances with rounded shapes.



# emco RADIAL

## with ribbed carpet insert

- Recommended for:** Indoor and covered outdoor areas
- Load-bearing capacity:** Heavy to very heavy
- Description:** Hard-wearing, curved entrance mat; installation frame and entrance mat as a single unit; for laying on the floor. Can be rolled over and also driven over by pallet trucks and goods vehicles. Mats produced to fit width and walking depth specifications perfectly, without the need for adjustment profiles. Any geometric shape is available.
- Passages:** From 2000 passages/day
- Suitability for wheeled traffic:** Wheelchairs, shopping trolleys, hand trolleys, pallet trucks
- Support chassis:** Made from rigid aluminium with sound insulation underlay
- Tread surface:** Recessed, robust, weather-proof ribbed carpet strips

**Non-slip properties:** R 11 slip resistance

**DIN 51130**

**Colours:** **Ribbed carpet:** standard: light grey, anthracite, beige, blue; special colours available: mauve, blue/grey, red, brown, turquoise, royal blue, sand and grape; refer to p. 22

**Connection:** Threaded steel rod

**Automatic door systems:** Profile clearance of 3 mm available as an option for automatic door systems, in accordance with DIN 18650

**DIN 18650**

**Full details:** [www.emco-bau.com](http://www.emco-bau.com)

Type	Standard profile clearance <sup>1)</sup> approx. (mm)	Approx. height (mm)	Weight (kg/m <sup>2</sup> )	Installation frame <sup>3)</sup>		
				Frame type	Dimensions in mm (H x W x D)	Material
522 RD/R	5	22	19,2	500/25	25 x 28 x 3	Aluminium
					25 x 25 x 3	Natural brass
					25 x 30 x 3	Stainless steel <sup>2)</sup>

Mat divisions as per factory standards, see p. 83

Load specifications see p. 84

<sup>1)</sup> Rubber spacers

<sup>2)</sup> Stainless steel, material no. 1.4301 (V2A)

<sup>3)</sup> For details of installation frames, see p. 70

For surcharges with mats that have curved designs, cut-outs and angled designs, see p. 82-83

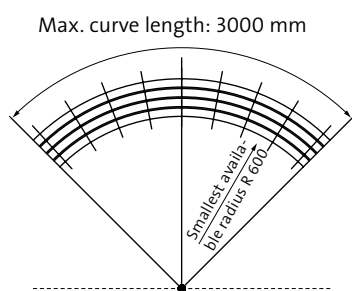

### emco RADIAL (RD) with ribbed carpet insert (R)

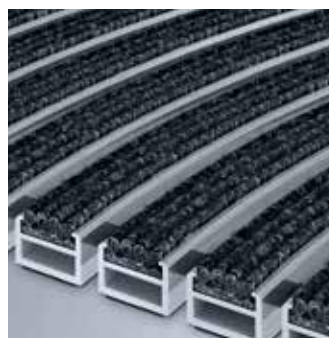

#### 522 RD/R

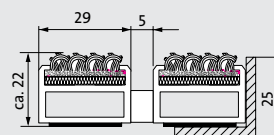



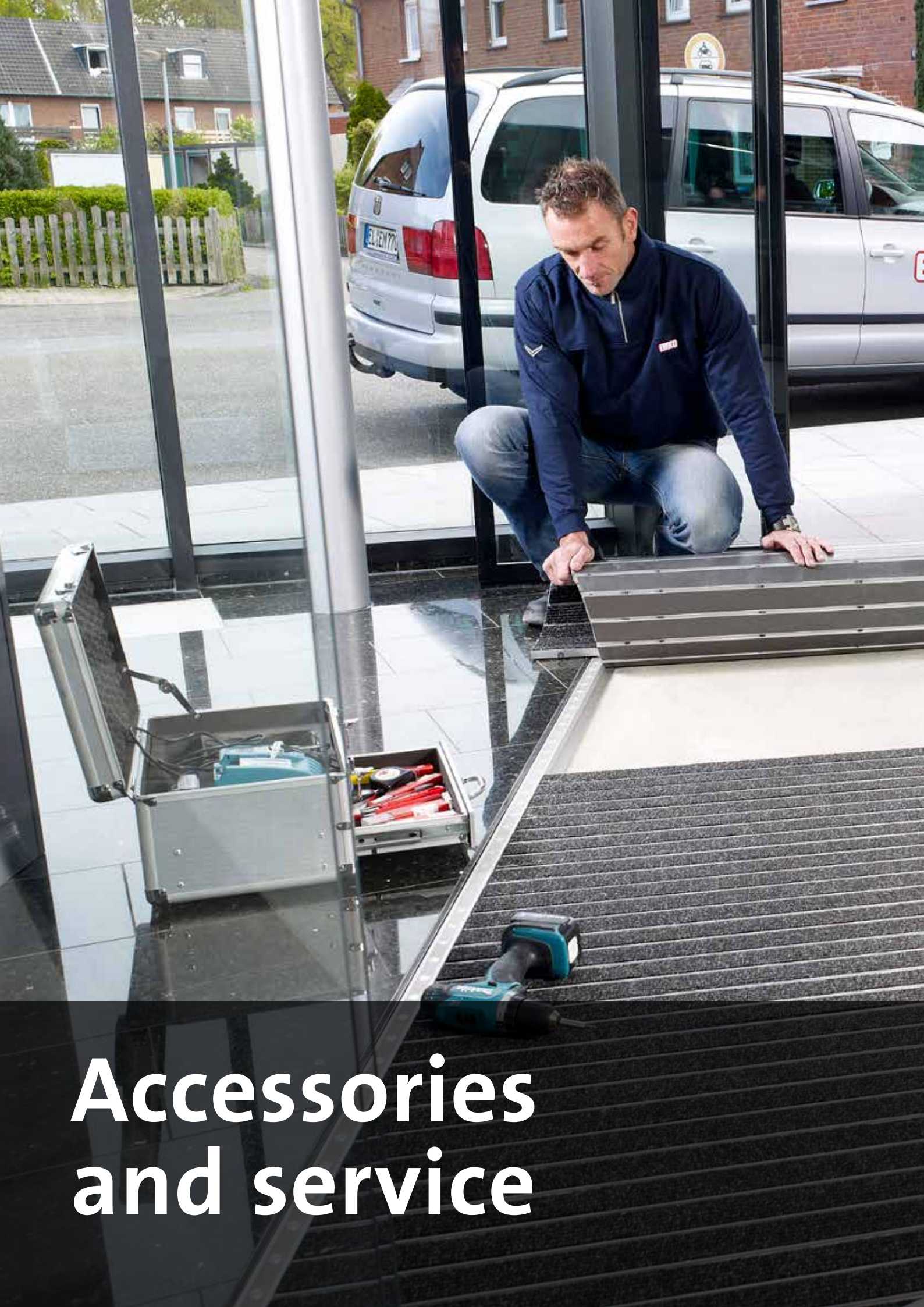

# Accessories and service



The customisation concept behind our entrance mats and entrance matting systems means they can be made to measure for each building. And this concept doesn't end at the edge of the mat. Well-thought-out accessories ensure perfect functioning and turn the entrance mat into an invitation to enter. Our service is just as tailored – from planning to laying and right through to cleaning your entrance mat.

## emco installation frame 500

The emco installation frame 500 consists of angled profiles with mitred corners. The sturdy gusset plates supplied ensure a screw connection that is true to size. The scope of delivery includes wall anchors; stainless steel versions for use in wet areas are available on request. The frame is supplied either ready for assembly or pre-assembled (e.g. in the case of frames with curved sections or several sections, etc.).

Type	Dimensions (H x W x D) in mm	Material
<b>500 / 13</b>	15,5 x 25 x 3	Aluminium
<b>500 / 18</b>	18 x 28 x 3	Aluminium
<b>500 / 20</b>	20 x 30 x 3	Aluminium
	20 x 25 x 3	Stainless steel*
<b>500 / 25</b>	25 x 28 x 3	Aluminium
	25 x 25 x 3	Natural brass
	25 x 30 x 3	Stainless steel*
<b>500 / 30</b>	30 x 30 x 3	Aluminium
	30 x 30 x 3	Natural brass
	30 x 25 x 3	Stainless steel*
<b>500 / 46</b>	47,5 x 35 x 4,5	Aluminium
	46 x 25 x 3	Stainless steel*

\*Material no. 1.4301 (V2A)



Aluminium version



Brass version



Stainless steel version

Full details: [www.emco-bau.com](http://www.emco-bau.com)

**Installation guide**

The emco frame (1) must be level with both the screed (2) in the mat well and the floor covering (3). Mat and mat well: The mat well base (4), which is usually screed, must be level. Any unevenness in the mat well must be smoothed out – we recommend using a self levelling smoothing compound. The emco frame anchor (5) is cast in the screed.

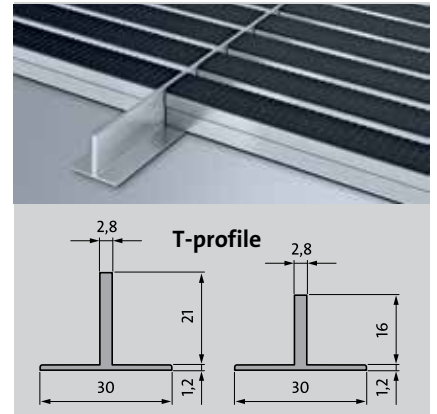
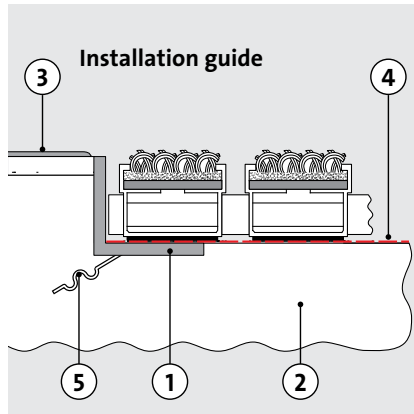

**emco T-profile**

Aluminium profile for creating visual separation of adjacent entrance mats. Available for mat heights of 17 and 22 mm.

**emco cover strip**

Brushed and ground surface (V2A); designed to protect and cover highly mitred and angled edges in specially shaped emco entrance mats.

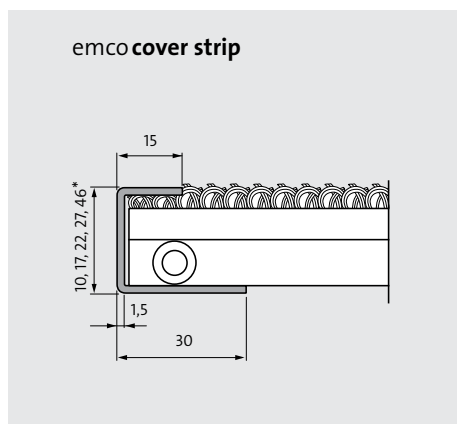

**emco ramp edge**

With its gradient, the emco ramp edge (with profiled tread surface made from aluminium) guarantees stumble-free access onto the mat. For emco DIPLOMAT entrance mats (heights 10, 17 and 22 mm) that are laid on finished floors at ground level.

\* The actual cover strip heights may be greater, depending on the specific material used

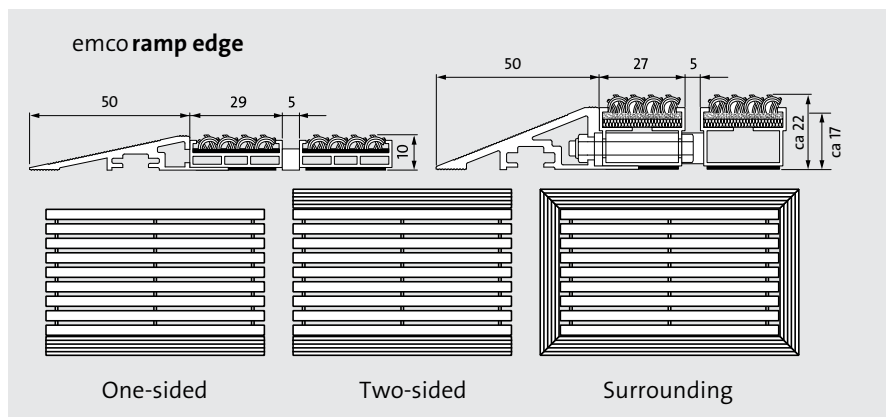

Type	Material	Material thickness (mm)
T-profile	Aluminium	1,2
Cover strip	Stainless steel*	1,5
Ramp edge	Aluminium	1,5

\* Material no. 1.4301 (V2A)

Full details: [www.emco-bau.com](http://www.emco-bau.com)



emco INOX® LINEO

Enhance your entrance area by incorporating lettering in a stainless steel profile into your emco entrance mat system. The text is laser-cut into a high-quality stainless steel profile, it comes in three heights (10, 17 and 22 mm) and is permanently integrated in the emco entrance mat system. Suitable for mat types DIPLOMAT 517, DIPLOMAT 522 and SENATOR.

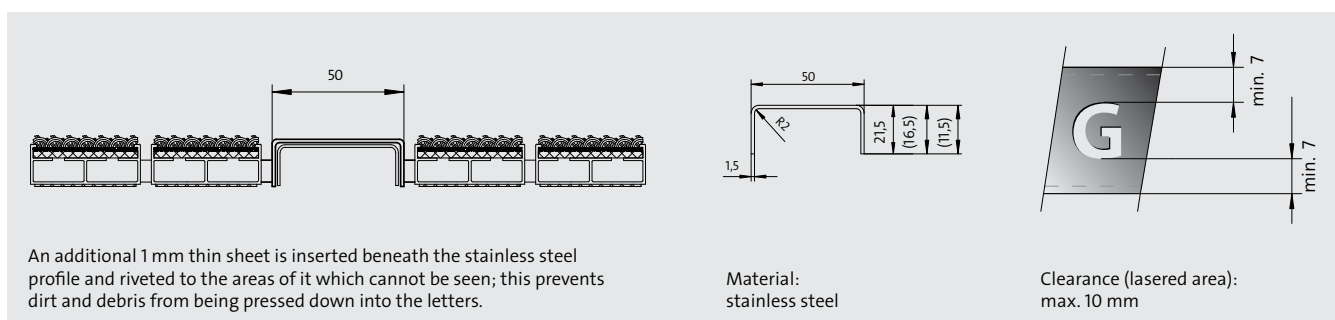

Type	Height (mm)	Material thickness (mm)	only for	Colour (max.)*
LINEO 12	12	1,5	DIPLOMAT 510	1
LINEO 17	17	1,5	DIPLOMAT 517	1
LINEO 22	22	1,5	DIPLOMAT 522 / SENATOR 522	1

- RAL 1023 Traffic yellow
- RAL 3020 Traffic red
- RAL 5002 Ultramarine blue
- RAL 7012 Basalt grey
- RAL 8007 Fawn brown
- RAL 6032 Signal green
- RAL 9005 Jet black

\*Optional colours available. Standard colour is black.

Full details: [www.emco-bau.com](http://www.emco-bau.com)



emco INOX® QUADRO

**NEW**

Stainless steel profile with individual lettering, with a prestigious logo plate for effective promotion in an entrance mat system. Special colours available. Suitable for mat types DIPLOMAT 517, DIPLOMAT 522 and SENATOR.



Find out more about the stainless steel profiles in the movie:

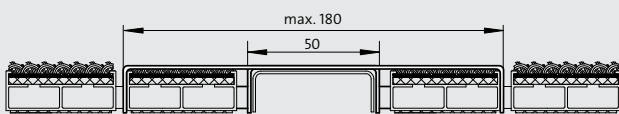

Material and processing like emco INOX® LINEO.  
Dimensions of the extended logo area: max. 300 x 180 mm



Clearance (lasered area): max. 10 mm

Type	Height (mm)	Material thickness (mm)	only for	Colour (max.)*
QUADRO 17	17	1,5	DIPLOMAT 517 (R), (G)	2
QUADRO 22	22	1,5	DIPLOMAT 517 (R), (G) SENATOR 522 (WR)	2

- RAL 1023 Traffic yellow
- RAL 3020 Traffic red
- RAL 5002 Ultramarine blue
- RAL 7012 Basalt grey
- RAL 8007 Fawn brown
- RAL 6032 Signal green
- RAL 9005 Jet black

\*Optional colours available. Standard colour is black.  
2 colour setup: one colour in the larger logo area and one in the text area.

Full details: [www.emco-bau.com](http://www.emco-bau.com)



**The illuminated frame system for entrance mats, also available with a stainless steel profile**

Combine emco's tried-and-tested entrance mats with the emco LED frame system can turn a simple entrance area into a real highlight. Airport, hotel or office building – the emco illuminated frame combines practicality with a unique type of elegance.



**Benefits of the emco LUMINA illuminated frame:**

- Highly energy-saving
- Easy to install
- Service life of up to 100,000 hours
- Waterproof, impact-resistant LED strip
- Suitable for indoor and outdoor use
- Tailored design options
- Cutting-edge design
- A stylish highlight



## emco LUMINA

The emco illuminated frame is composed of a base section and an LED holder section, made from anodised aluminium in a natural colour. The LEDs are enclosed in transparent plastic, making them waterproof (IP66) and impact-resistant, and are fitted to the top of the holder section. The electrical installation of the light fitting complies with international protection class IP66. The holder section clicks into the base section from the side, and the LED technology is integrated into the interior. The emco illuminated frame has a top edge of 30 mm, a bottom edge of 52 mm and a height of 25 mm, and can be combined with all emco entrance mat types with an installation height of 22 mm (special shapes are not available). The LED hose is fixed to the LED holder section, and has dimensions of 6 x 12 mm.

**Frame material:** Al Mg Si 0.5

**Frame dimensions:** 25 x 30 x 52 x 2.8 mm

**Surface for both profiles:** Natural colour, anodised E6 CO

**Max. profile length:** 3.5 m

**Appearance of base profile (visible surface):** With longitudinal grooves

**Frame for mat height:** 22 mm

**Suitable mat types:** DIPLOMAT, MARSCHALL, SENATOR; with 22 mm construction height

**Illumination:** Both sides of the entrance matting system installed.

**LED spacing:** 57.3 mm

**Material covering cap:** Transparent plastic

**LED colour:** White

**Temperature range:** -40 to +85°C

**Voltage:** 24 V

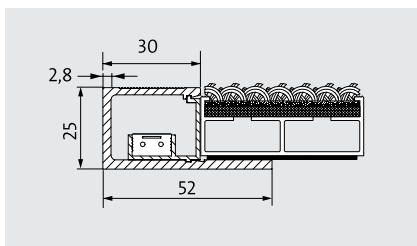

## emco LUMINA VIA

The emco LUMINA VIA illuminated frame system is the elegant and convenient solution that is designed to enhance and supplement your emco mat systems. Choose the specific colours you want for the emco illuminated frame and select a control method from the following three options: remote control, iPad or smartphone. emco LUMINA VIA is set in an aluminium installation profile and is suitable for both indoor and outdoor areas. The emco illuminated frame system can be walked on and driven over.

**Angled/cover profile:** Aluminium EN

AW-6060 T66, natural anodised\*

**Nominal voltage:** 12 VDC

**LED colours:** White/RGB (multicolour)

**Power, monochrome:** 7 W/run. m

**Power, RGB/multicolour:** 7.5 W/run. m

**LED service life:** Up to 100,000 h

**Ambient temperature:** -40 to +85°C

**Protection class:** III extra-low voltage

**Degree of protection (illuminated frame):** IP68 (3 m)

**Material:** Aluminium, fully encapsulated  
**Encapsulation:** 2-component polyurethane casting resin

**Load-bearing capacity:** Suitable for installation in floors and for walking on/for wheelchairs/trolleys etc. with inflated tyres, 30 kN (acc. to DIN EN 60598-2-13)

**UV resistance:** Exists

**Weight:** Approx. 750 g/run. m

**Connectors:** Butt connector/corner connector 90°\*

\* Others available on request

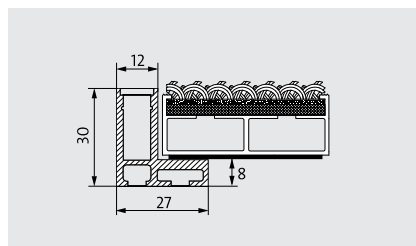

Full details: [www.emco-bau.com](http://www.emco-bau.com)

emco entrance mats are constructed in such a way that the majority of the dirt falls through the gaps and into the mat well. Nevertheless, regular care and cleaning are necessary in order to prolong the effectiveness and service life of the mat. Cleaning intervals, tools and agents used will vary depending on the type and intensity of the soiling.

The length of care and cleaning intervals should be adapted in line with how often people walk across the mat and the loads it is required to withstand. It is also important to consider the time of year: the snow and de-icing salt that the mat is exposed to during the winter months require shorter cleaning intervals, particularly in areas with heavy loads. For this reason, we recommend cleaning the mats daily. In heavily frequented entrance areas, emco dirt collection wells with drainage systems are a must (these are used with emco MARSCHALL and PLAZA entrance mats).

### General cleaning:



Daily general cleaning

A powerful brush vacuum cleaner should be used for daily cleaning of emco entrance mats with ribbed carpet inserts. The brushing action during vacuuming makes the fibres stand up again and allows the dirt to be sucked out of the gaps in the ribbed carpet insert.

### Thorough cleaning:



Weekly intermediate cleaning

After vacuuming, the emco entrance mats should be rolled up and the mat well swept clean with a broom or vacuumed.

### Intermediate cleaning:



Monthly thorough cleaning

After vacuuming and cleaning the mat well, the mat can be hosed down with a high-pressure cleaner. After being stood up to dry for a short period, the mat can be returned to service. Cleaning using a standard industrial cleaning machine is also possible.

Find out more about  
cleaning our entrance  
mats in the movie:



**emco cleaning service:**



Annual special emco cleaning service

Our special cleaning vehicle is a world first and enables us to clean your emco entrance mats thoroughly as well as pre-dry them – directly on site! We don't even need a water or power supply – and what's more, we ensure that the dirty water is disposed of using an environmentally friendly method.

Our service employees work on site to ensure that emco entrance mats are cleaned correctly and replace ribbed carpet inserts when necessary – using a quick, fuss-free process. This service is not available in the UK.

**Ribbed carpet replacement by our emco service team:**



Every 3 years: ribbed carpet replacement by our emco service team

Particularly in entrance areas, it is not always possible to avoid damage altogether – whether this is caused by cigarette burns, chewing gum, or even oil stains. Moreover, anything that is trodden on hundreds of thousands of times will inevitably need to be replaced. This is where emco's ribbed carpet replacement service, which can increase the cost effectiveness of entrance mats several times over, comes in. The metal chassis is retained: only the ribbed carpet strips are replaced in a systematic way. Equipped with a mobile ribbed carpet replacement machine, our service team is constantly on hand so that your ribbed carpet can be replaced.

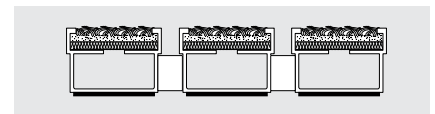

Hardly any cleaning effectiveness remains

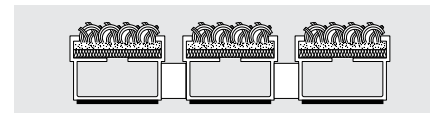

Full cleaning effectiveness with new ribbed carpet inserts

Extremely worn ribbed carpet inserts should be replaced at specified intervals or if they are exceptionally heavily soiled.



Find out more about ribbed carpet replacement in the movie:

**emco sales aids:**

The ideal way to present our entrance mat systems – the mat presentation stand (265-0198):

- approx. W x H x D: 105 x 200 x 85 cm
- 5 shelves for sample mats
- 5 shelf strips with labels
- 5 entrance mat samples (065-1598)
- Topper (855-4288)
- leaflet box DIN A4
- 100 leaflets (855-4630)
- emco logo

The entrance mat samples (approx. W 587 x D 389 mm, 065-1598) consist of:

- emco DIPLOMAT 522 CB with cassette brush insert
- emco SENATOR 522 W/R with extra-wide ribbed carpet insert (anthracite) and stainless steel profile
- emco DIPLOMAT 522 GB with rubber insert and brush strip
- emco DIPLOMAT 510 R with ribbed carpet insert (anthracite)
- emco DIPLOMAT 522 R with ribbed carpet insert (light grey)
- sample frame type 500/N: W 600 x D 400 mm



## emco entrance mats – Measuring and installing

### If supplied with a frame:

Please state the outer dimensions of the frame.

### If the frame is fitted:

Please state the inner dimensions of the frame.

### For special shapes:

Please contact our Service Department, who will be happy to give you the benefit of their technical expertise (e.g. using a laser measurement device).

This service is not available in the UK

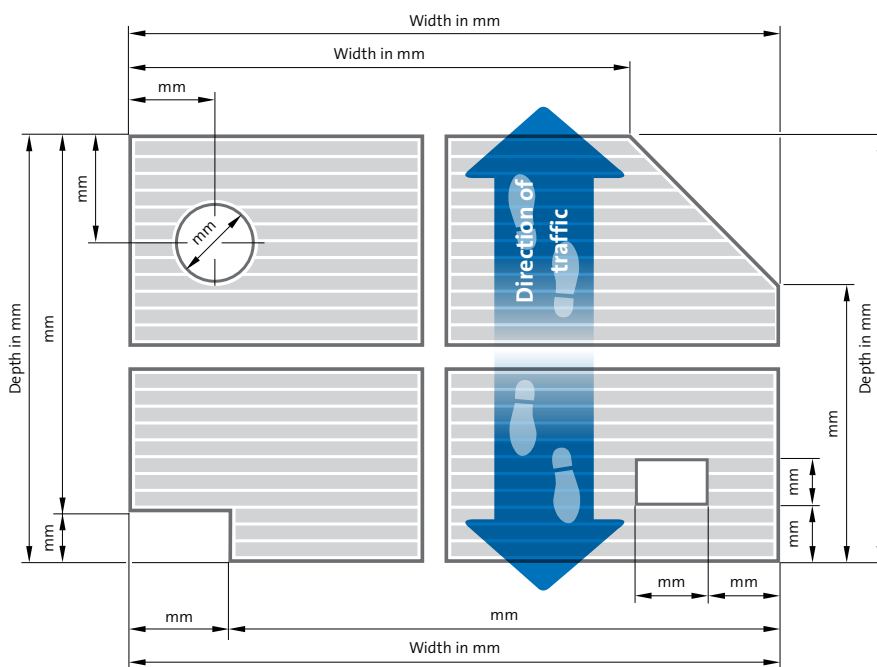
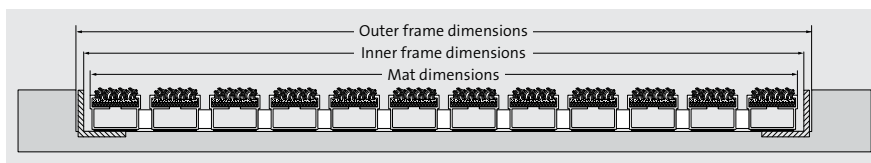

### emco mat joining brackets for joining individual mat sections:

emco mat joining brackets made from stainless steel for easy connection of larger, divided entrance mats and precise section assembly. The joining brackets are supplied free of charge with every order (available for all types except GS17 and PLAZA).

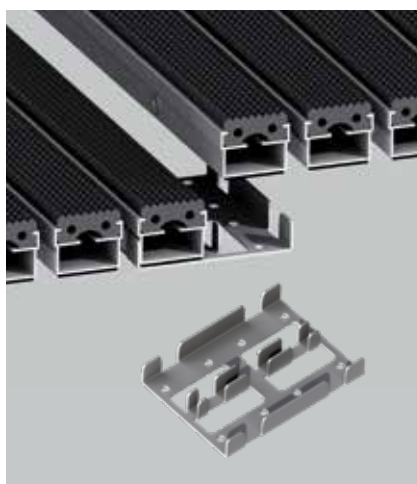

### During planning, please note:

The entrance mat profiles should run at right angles to the direction of traffic.

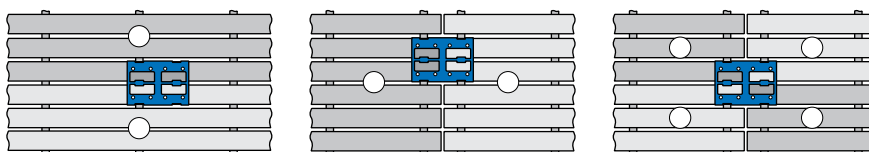

## Mat combinations as per factory standards:

For situations where mats need to be divided: as a general rule, emco entrance mats are supplied in a single piece whenever possible.

Type	Max. width (mm)*	Max. walking depth for each individual section (mm)*	Maximum mat weight (kg)
DIPLOMAT	3000	3000	45
DIPLOMAT 510	2200	1500	25
MARSCHALL	3000	3000	45
PLAZA	2800	1000	45
ECOLINE PIONEER	1900	3000	45
SENATOR	3000	1500/800	45
SPIN® SAFE	1200	800	45
GS 17	2000	800	45
KADETT 515	2600	1500	30

\*These values relate to the specified maximum mat weight

## Pricing

### Standard designs:

In the case of mats and frames that have a straightforward rectangular or square shape (90° corners), the area is determined by multiplying the width by the length. The list price that applies in each case is then used as the basis for pricing.

### Special solutions:

#### Basis for pricing

- Mats with areas of less than 2 m<sup>2</sup>:  
The full rectangular area is used as the basis for pricing.
- Mats with areas of more than 2 m<sup>2</sup>:  
The actual dimensions of the mat are used as the basis for pricing.  
Cut-outs – for doorstops for example – are factored into the area calculation.

### Surcharges for special services/shapes:

For types DIPLOMAT 522, MARSCHALL 522S, PLAZA 542S and GS 17, the following applies: Surcharges are levied for cut-outs (round/square), as well as curved and angled designs. Please refer to our separate price list for the most up-to-date information on surcharges.

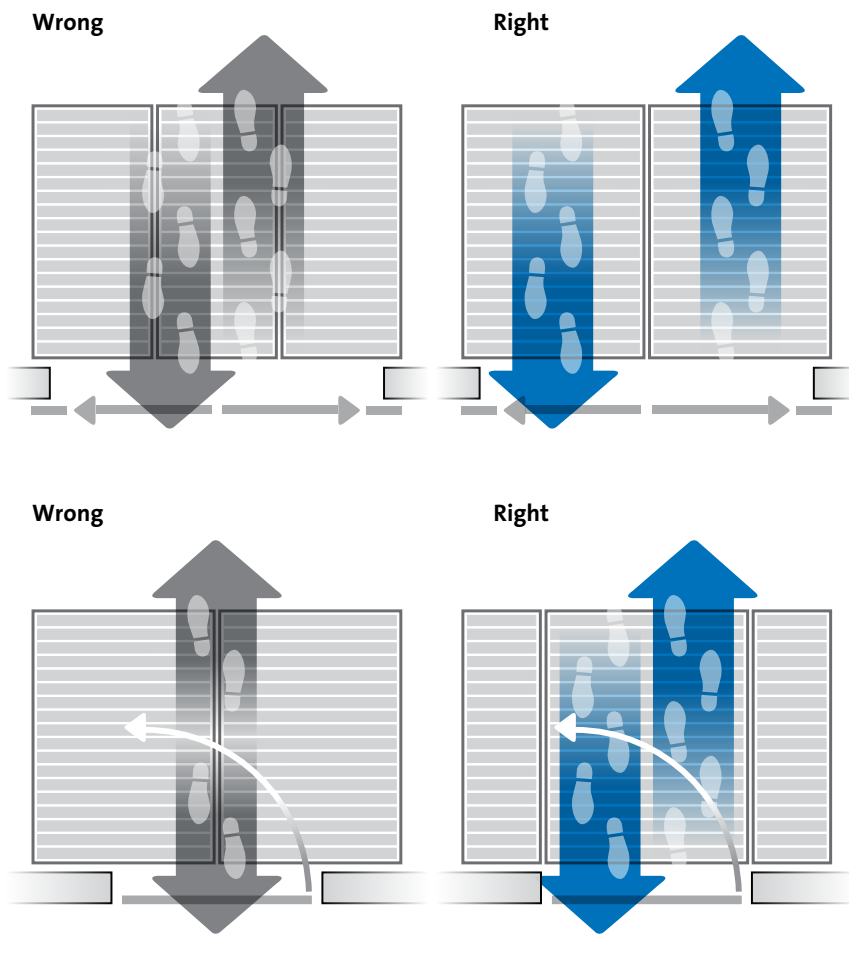

## emco load specifications and profen quality

	DIPLOMAT 510	DIPLOMAT 517	DIPLOMAT 522	DIPLOMAT 527	SENATOR 522 W	SENATOR 522 WS	Suitability for wheeled traffic
Type of installation	Stationary load kg/100 cm <sup>2</sup>	Stationary load kg/100 cm <sup>2</sup>	Stationary load kg/100 cm <sup>2</sup>	Stationary load kg/100 cm <sup>2</sup>	Stationary load kg/100 cm <sup>2</sup>	Stationary load kg/100 cm <sup>2</sup>	Shopping trolleys, wheelchairs, hand trolleys (caution with GB, GK, GCB, CB!)*
Fully supported	1500	2100	2100	2100	2100	3500	

	MARSCHALL 5175		MARSCHALL 5225		PLAZA 5425		
Type of installation	Stationary load kg/100 cm <sup>2</sup>	Suitability for wheeled traffic	Stationary load kg/100 cm <sup>2</sup>	Suitability for wheeled traffic	Stationary load kg/100 cm <sup>2</sup>	Suitability for wheeled traffic	
Fully supported	3550	Shopping trolleys, wheelchairs, hand trolleys, cars and pallet trucks	3590	Shopping trolleys, wheelchairs, hand trolleys, forklift trucks, cars and pallet trucks	4500	Shopping trolleys, wheelchairs, hand trolleys, pallet trucks, cars and HGVs (up to 7.5 t)	
<b>Self-supporting**</b> with substructure	150		300		830	Without grid support	Shopping trolleys, wheelchairs, hand trolleys, cars and pallet trucks
<b>Extent of support</b> with substructure	With grid support		With grid support		1070		
<b>250 mm</b> with substructure	400		665		830		
<b>300 mm</b> with substructure	355		615		640		
<b>350 mm</b> with substructure	310		575		460		
<b>400 mm</b> with substructure	280		535		408		
<b>450 mm</b> with substructure	250		490		340		
<b>500 mm</b> with substructure	225		435		265		
<b>550 mm</b> with substructure	200		380		210		
<b>600 mm</b> with substructure	165		325				
Self-supporting with dirt collection well type 50xx ***	150		300		Shopping trolleys, wheelchairs and hand trolleys		

\*Versions featuring brush strips, scraper bars and cassette brushes are only suitable for wheeled traffic under certain conditions. Please contact us for further information.

\*\*Support clearance: max. 300 mm \*\*\*For technical data, refer to p. 76

**Important note: Sudden acceleration and turning on the mat should generally be avoided due to the excessive force and/or point loading these cause.**



**Detecting and solving problems**

Around 80% of the dirt in a building is tracked in from outside and then is spread across a larger area by internal traffic. For stone coverings, this results in cracks, stains and dulled colours; textile coverings also lose their colour intensity and experience a reduction in the quality of their material. In turn, this leads to premature deterioration of the floor coverings. emco clean-off systems counteract these problems by absorbing a high proportion of the residual and damp dirt right at the entrance area – and, as a result, provides protection for the adjacent floor coverings.

**Improve your image – and know it will stay that way**

emco clean-off systems ensure that the first impression you give will be a good one. A well-maintained, clean entrance area in harmonious colours makes a valuable contribution to the positive overall image of business premises or public buildings. The sound-absorbing effect of these systems also creates a relaxing, pleasant atmosphere. In addition to this, emco clean-off systems actively prevent the risk of slippages caused by moisture and dirt in entrance areas – as well as the slips and trips associated with this. Hygiene conditions in heavily frequented areas are significantly improved.

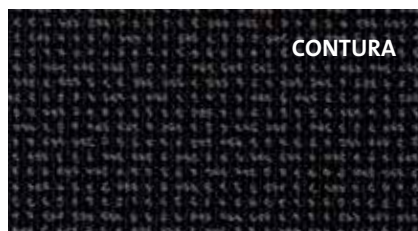
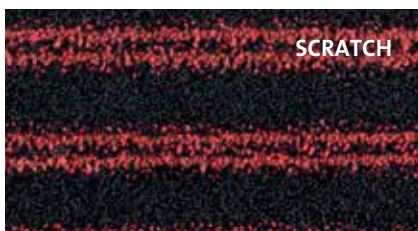
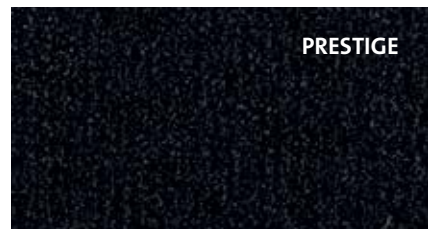
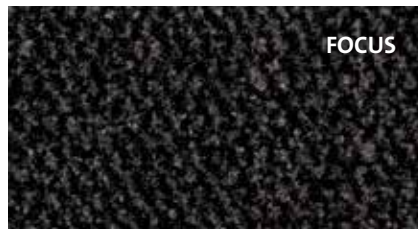
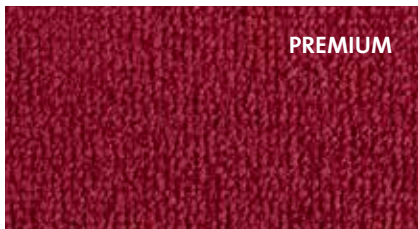
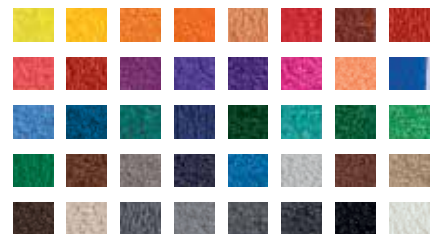



**emco advertisements on logo mats**

If you're looking for an opportunity for advertising and image promotion in addition to a cleaning system, emco logo mats are the right choice for you – and a way to enhance your emco entrance matting systems. emco is the only manufacturer in Germany to produce logo mats with individually tailored colours and motifs made from high-quality high twist nylon. The backing material, made from flexible nitrile rubber, is able to withstand repeated cleaning and washing. Certification to DIN ISO 9001 and the latest machinery ensure a superior level of quality. emco's wide sales network is yet another of the advantages we offer. In Germany alone, around 30 members of our service staff are on hand to dispense advice quickly and ensure deliveries are rapid too.



## emco gratings and foot grids

### emco **swimming pool gratings**

A quality product allowing splash water to drain and featuring a perfectly-sized free cross-section; gentle on the feet and hygienic. emco offers swimming pool grates in rigid or roll-up formats, with either lateral or longitudinal profiles, and with a variety of dimensions and corner solutions available. In addition, the option of radial gratings running at right angles or parallel to the edge of the pool opens up a number of possibilities in terms of design. They are resistant to UV rays, as well as chlorine, sea water and spa water, and boast optimum non-slip properties thanks to their safety profile seal.

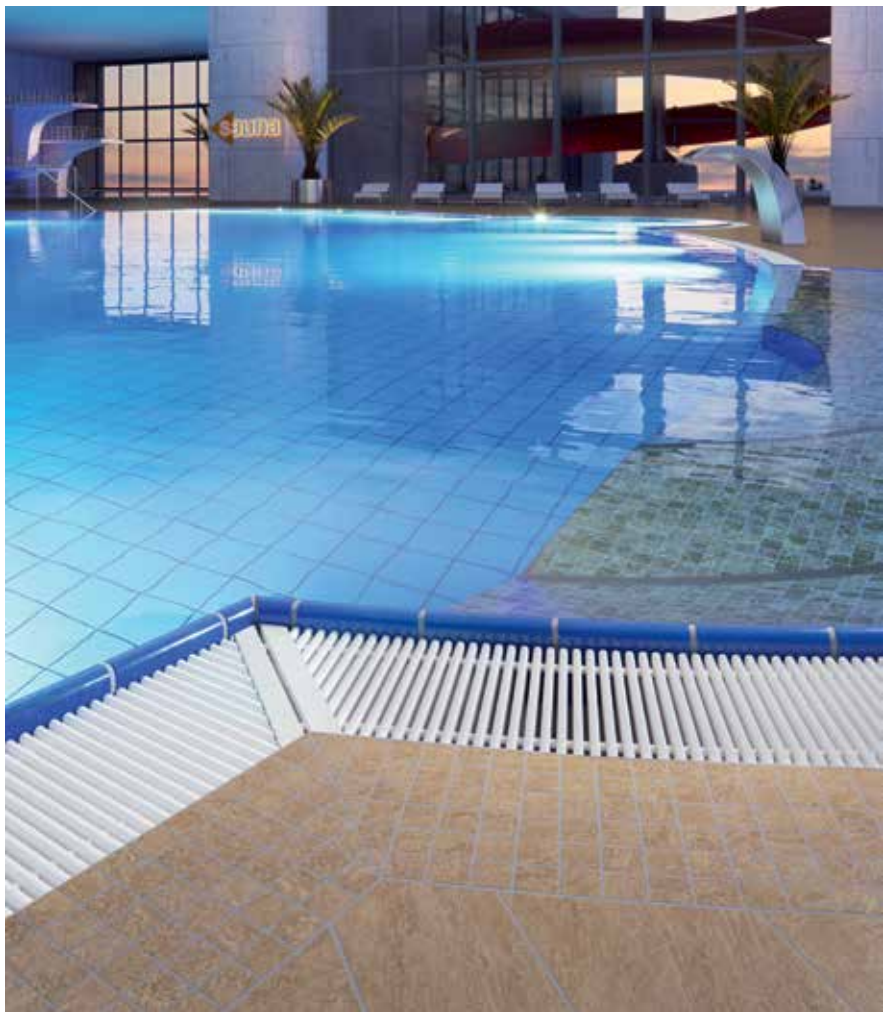

### emco **rolling foot grids**

emco creates the freedom to enjoy life more effectively in domestic, commercial and industrial areas: With emco roller grilles providing walk-on coverings for convector shafts and ventilation shafts that can be supplied in aluminium (anodised on request) and stainless steel, emco offers a variety of profile types with a selection of free cross-sections. They can be supplied with matching emco installation frames on request. Special designs in any conceivable shape, as well as versions for corner and curved applications, are also available.

